







# ASSEMBLY INSTRUCTION

## 4829LN CLICK CLACK

### 4829LN-A ARMS

Thank you for purchasing this quality product. Be sure to check all packing material carefully for small parts that may have come loose inside the carton during shipment.

PART LIST: (NOTE:HARDWARE PACK INSIDE THE CARTON OF 4829DB-A)

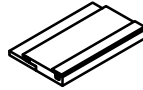
A:  Bun Feet 4PCS	B:  Bolt 4PCS	C:  Washer 4PCS	D:  Allen Key 1PC
E:  Screw 6PCS	F:  LSF Arm 1PC	G:  RSF Arm 1PC	H:  Sofa Bed Frame 1PC

### 1. ASSEMBLY

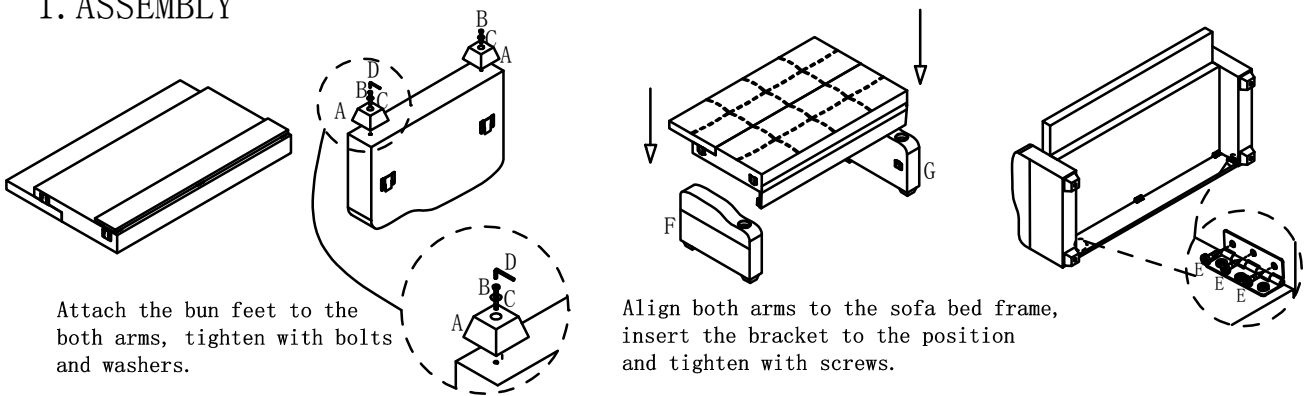

### 2. USE AS SOFA POSITION

Pull up the back to upward position with one click till fully upright.

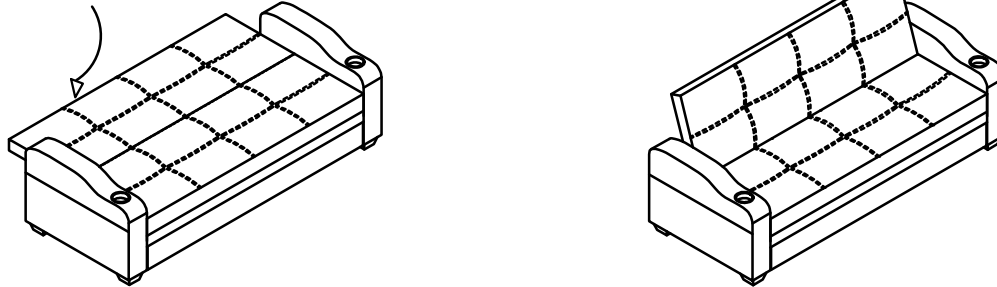

### 3. USE AS BED POSITION

Pull out the support legs from the sofa back.

Push the back to the end of front then pull down the back to the flat position till the end.

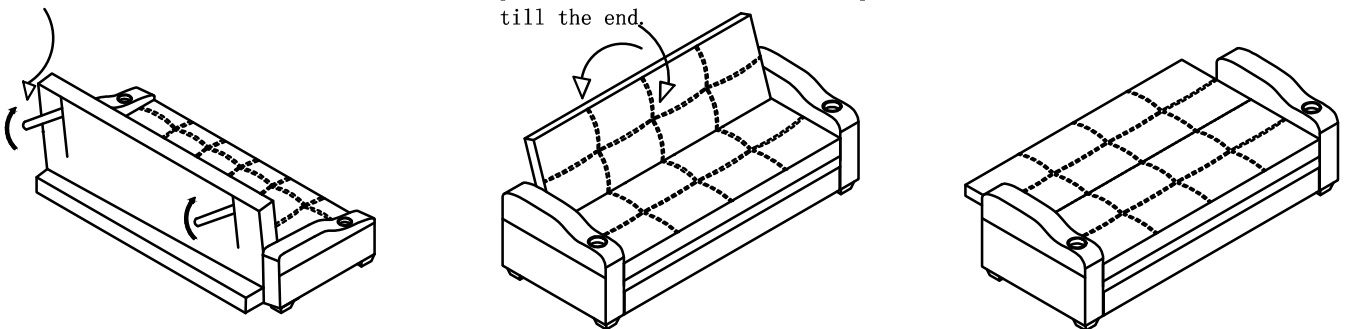

For items use on wooden floor, hard surfaces or carpets, it is recommended to Install protective pads under all legs and supports to avoid/prevent from damages/scratches and discoloration.