

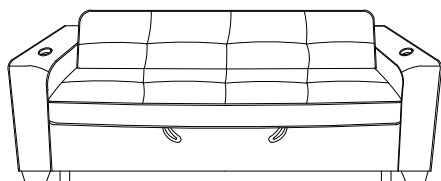

# ASSEMBLY INSTRUCTIONS

ITEM NO:9258

CONVERTIBLE SOFA WITH HIDDEN STORAGE,  
CUP HOLDERS AND USB PORTS







Thank you for purchasing this product. Please take time to read and follow the instructions below. Check that you have all parts and hardware before assembly. Parts apparently missing are often found in the packing materials. If you do not have all the parts listed, have your dealer contact us and they be sent to you immediately.



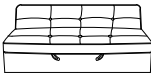



It is recommended to install protective pads under all legs and support to avoid damage or scratches when placing furniture on a wood floor or other hard surface, and to limit Indentation and prevent discoloration if placing on carpet.

## PARTS LIST

NO.	DESCRIPTION	DRAWING	QTY
A		Seat	1 PC
B		LSF Arm	1 PC
C		RSF Arm	1 PC
D		Adaptor with Y Cable	1 PC
E		Wooden Leg	4 PCS

## HARDWARE LIST

NO.	SKETCH	SIZE	QTY
1		BOLT (Ø5/16"-18 x 2"L)	4 PCS
2		SPRING WASHER (Ø5/16" x 13/32" x 0.08")	4 PCS
3		FLAT WASHER (Ø5/16" x 23/32" x 0.08")	4 PCS
4		ALLEN KEY (1/6" x 2-3/8"L)	1 PC

### STEP 1:

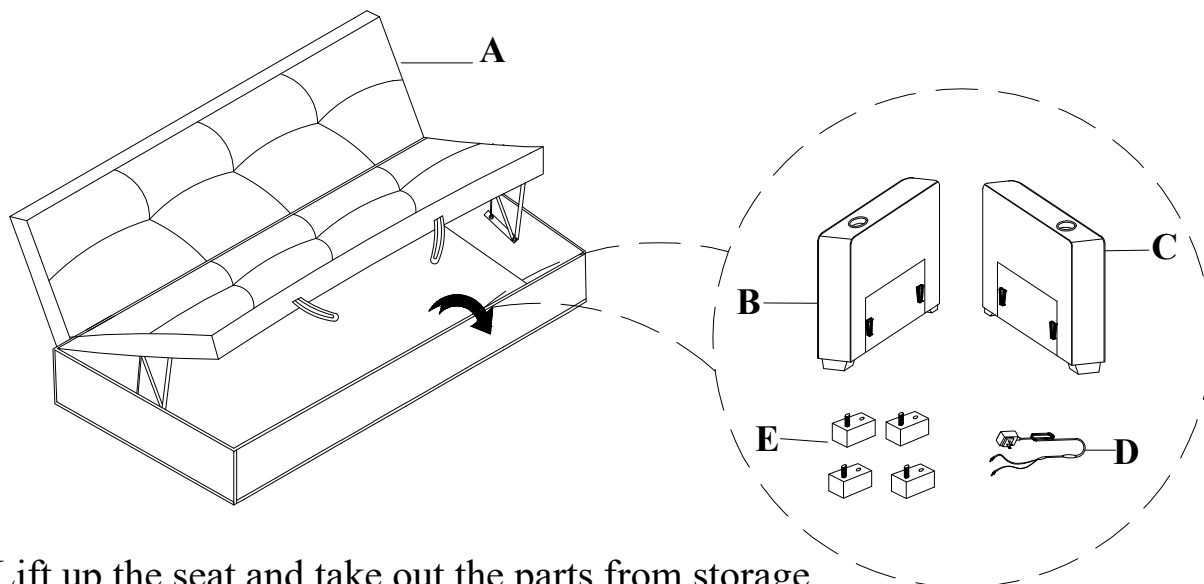

Remark: Lift up the seat and take out the parts from storage for assembly.



# ASSEMBLY INSTRUCTIONS

ITEM NO:9258

CONVERTIBLE SOFA WITH HIDDEN STORAGE,  
CUP HOLDERS AND USB PORTS

## STEP 2:

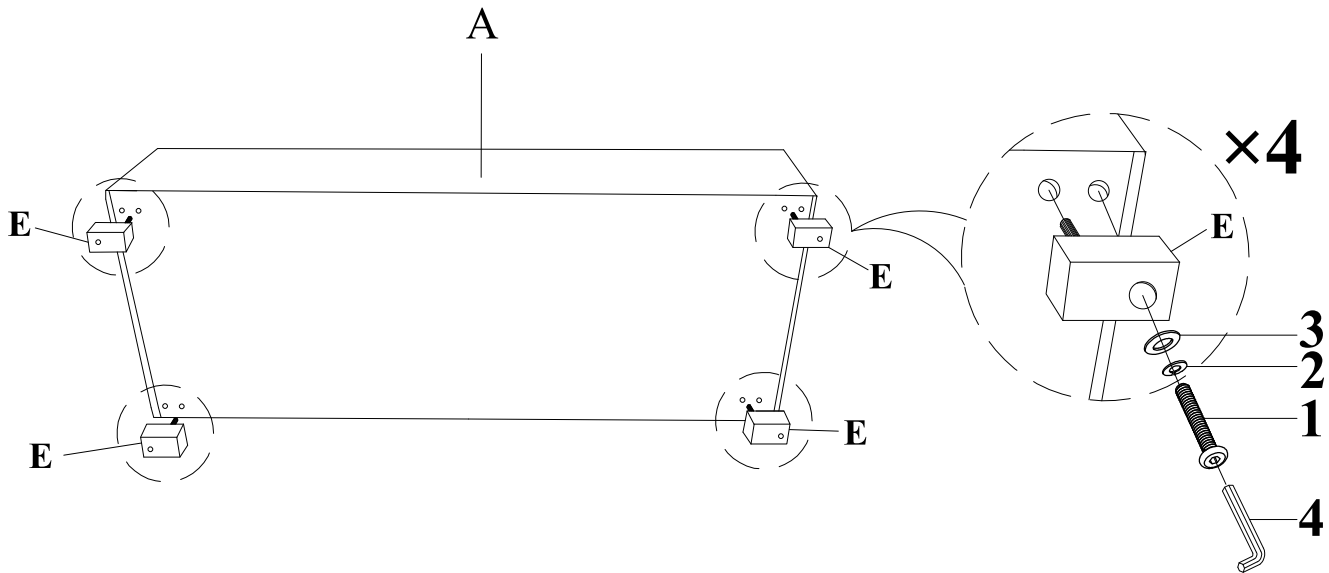

## STEP 3:

Remark:  
When install arm, side with cup holder must facing front.

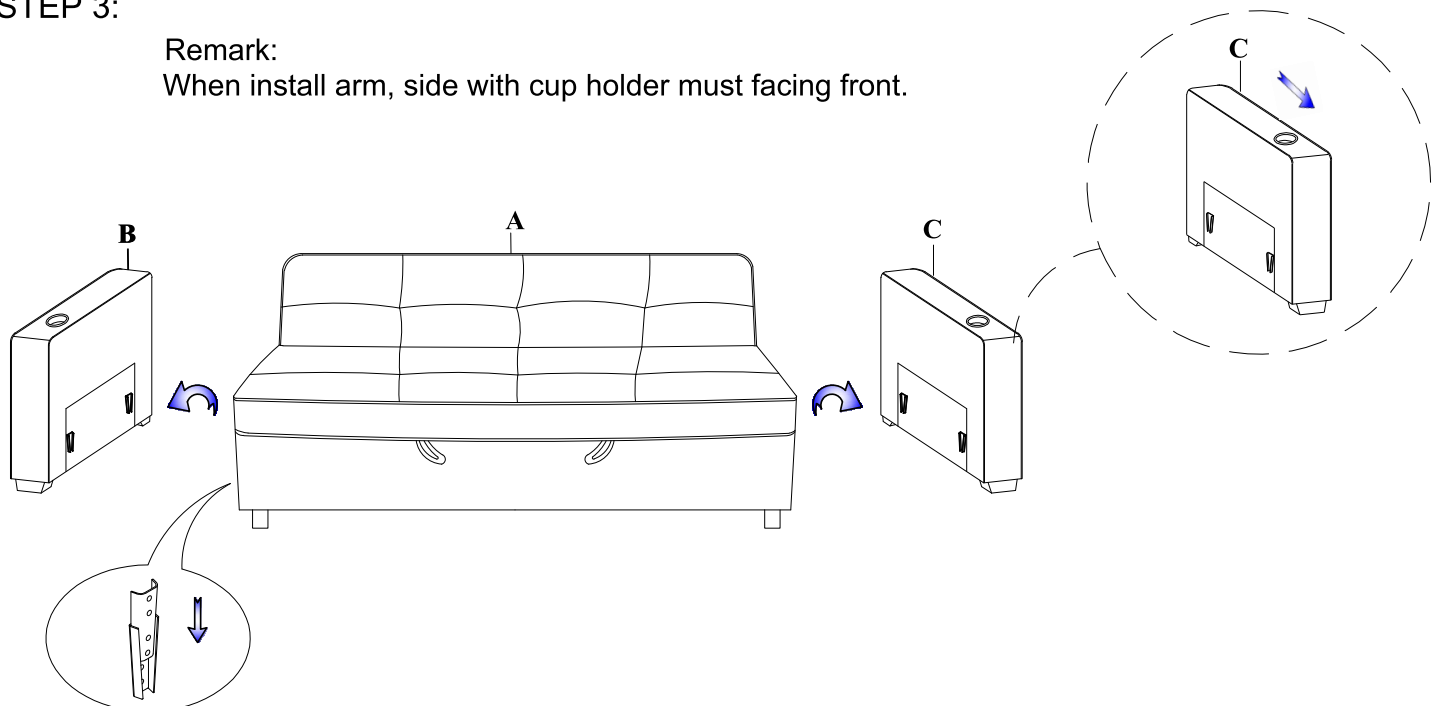



# ASSEMBLY INSTRUCTIONS

ITEM NO:9258

CONVERTIBLE SOFA WITH HIDDEN STORAGE,  
CUP HOLDERS AND USB PORTS

STEP 4:

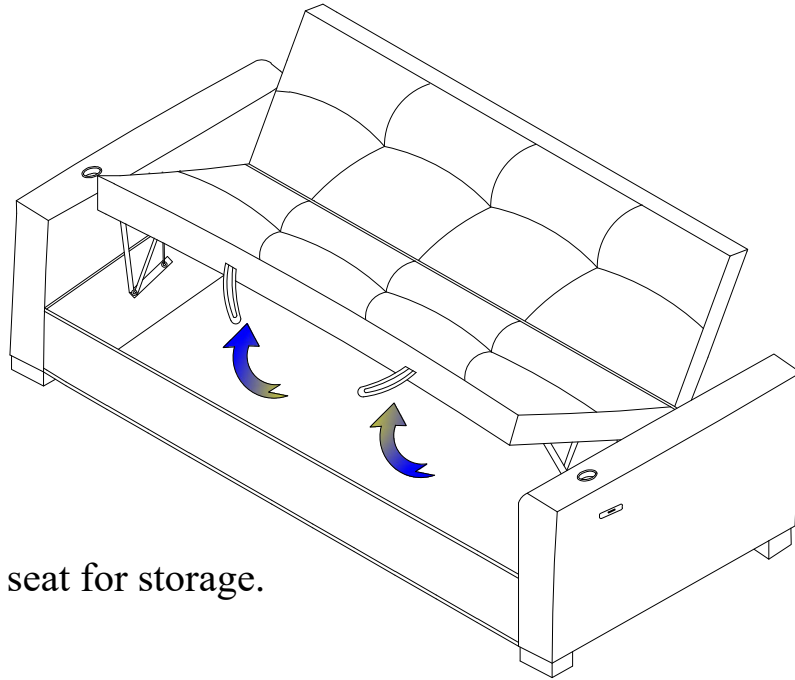

Remark: Lift up the seat for storage.

STEP 5:

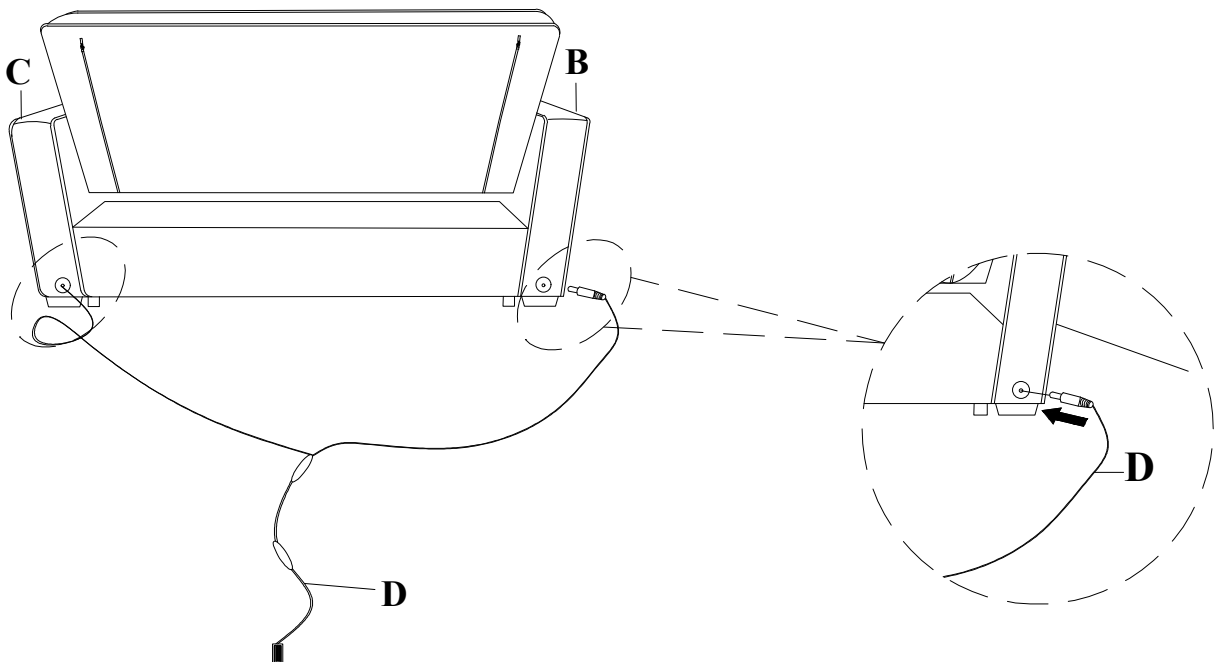



## ASSEMBLY INSTRUCTIONS

ITEM NO:9258

CONVERTIBLE SOFA WITH HIDDEN STORAGE,  
CUP HOLDERS AND USB PORTS

### STEP 6:

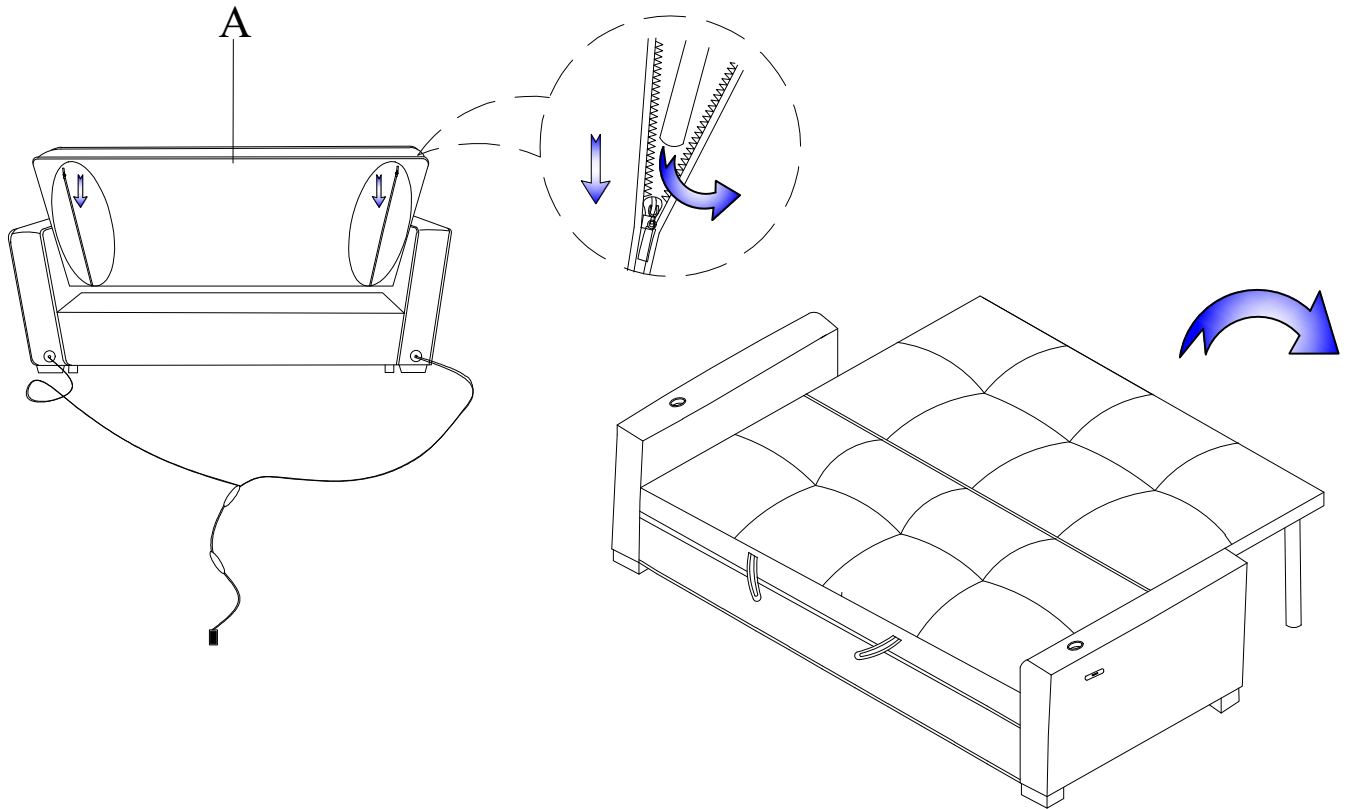

### Care Instruction for Velvet Furniture:

In order to maintain the original appearance of your Velvet Furniture, please follow below simple care procedures:

- Avoid exposing furniture directly to sunlight or heating and air conditioning outlets. Sunlight and or exposure to heating and air conditioning outlets will fade/damage Velvet.
- Vacuum or wipe with a soft cloth to remove dust.
- Hardware may loosen over time. Periodically check to make sure all connection are tight, Re-tighten if necessary.



For items use on wooden floor, hard surfaces or carpets, it is recommended to Install protective pads under all legs and supports to avoid/prevent from damages/scratches and discoloration.



## ASSEMBLY INSTRUCTIONS

ITEM NO:9258

CONVERTIBLE SOFA WITH HIDDEN STORAGE,  
CUP HOLDERS AND USB PORTS

**CAUTION:** Changes or modifications not expressly approved by the party responsible for compliance could void the user's authority to operate the equipment.

Note: This equipment has been tested and found to comply with the limits for a Class B digital device, pursuant to part 15 of the FCC Rules. These limits are designed to provide reasonable protection against harmful interference in a residential installation. This equipment generates, uses and can radiate radio frequency energy and, if not installed and used in accordance with the instructions, may cause harmful interference to radio communications. However, there is no guarantee that interference will not occur in a particular installation. If this equipment does cause harmful interference to radio or television reception, which can be determined by turning the equipment on and off, the user is encouraged to try to correct the interference by one or more of the following measures:

- Reorient or relocate the receiving antenna.
- Increase the separation between the equipment and receiver.
- Connect the equipment into an outlet on a circuit different from that to which the receiver is connected.
- Consult the dealer or an experienced radio/TV technician for help.

**▲ WARNING:** To avoid serious injury:

- Carefully and strictly follow assembly instructions.  
Improper assembly of furniture can result in structural failure, instability of the product or tip-over.
- Monitor and carefully control the assembly components.  
These include small parts and hardware that may present a choking hazard to small children.
- Where provided, wall mounting hardware should always be used as prescribed in these instructions to anchor furniture to walls.  
Proper use of the wall mounting can significantly reduce the potential for furniture tip-over and crush injuries.

#### Technique Parameter

- USB Input voltage: 5V/2.0A
- USB output voltage: 5V/1.5 - 2.0A
- Charging efficiency: 75% MAX