

Assembly Instruction

ITEM NO.:9428CB-3CL 9428NV-3CL 9428RN-3CL







Convertible Studio Sofa with pull-out bed

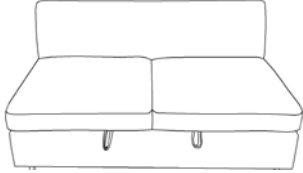
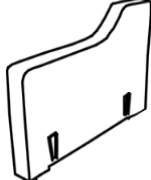

Legs and hardware are stored in the bubble bag and located underneath the trundle, please take out for assembly.

Note: Do not use power tools for assembly. Power tools increase the risk of over tightening which lead to splitting or cracking the wood

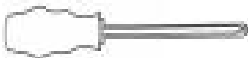
Component list .

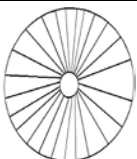
Label	Picture	Description	QTY(pc)
A		Sofa seat	1
B		LSF ARM	1
C		RSF ARM	1
D		Metal Trundle Leg 1.97"*0.98"*4.92"	4
E		Screw φ0.15"*0.98"	16
F		Screwdriver	1
G		Back Cushion	2
H		Plastic leg 4.7"	4
I		Plastic Gasket	4

Step #

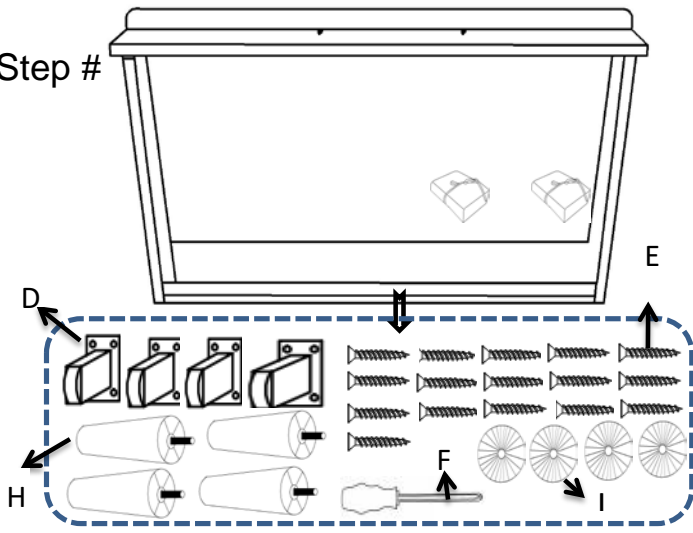

Step #2

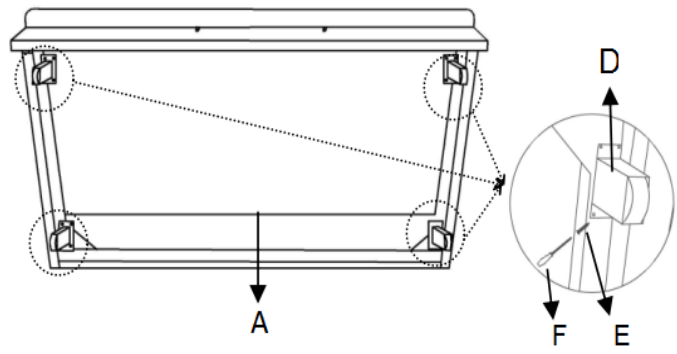

Step #3

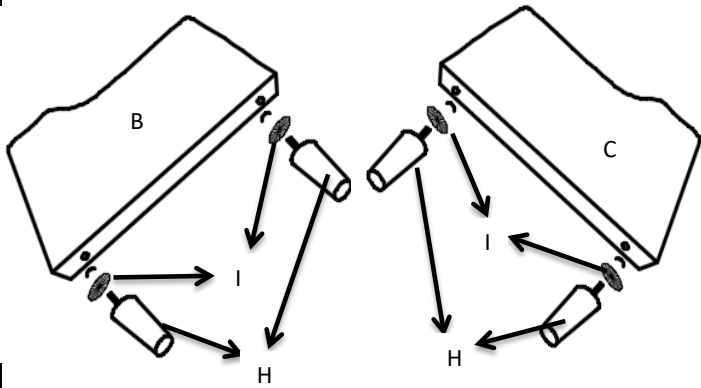

Step #4

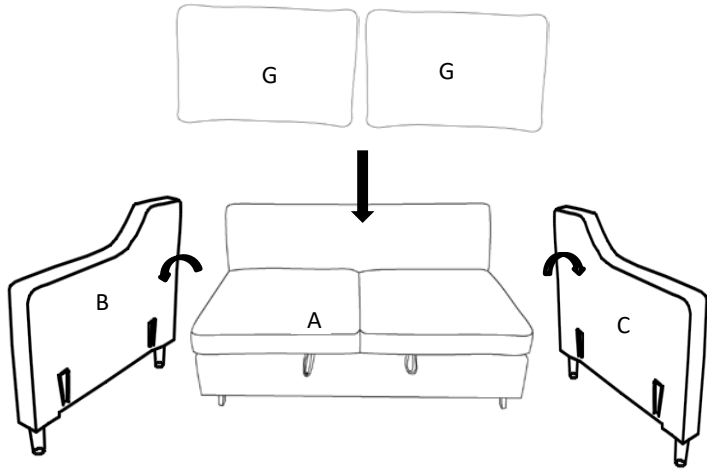

Step #5

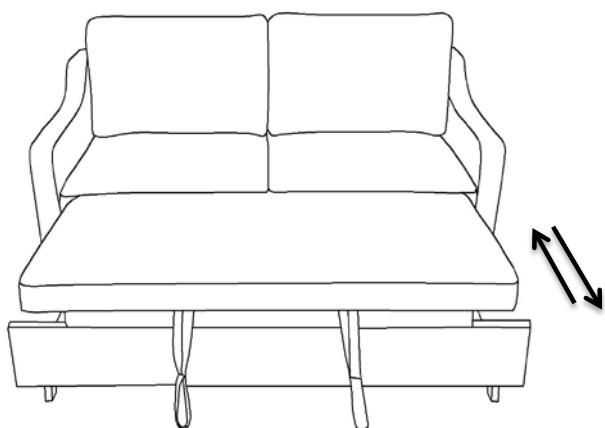

Step #6

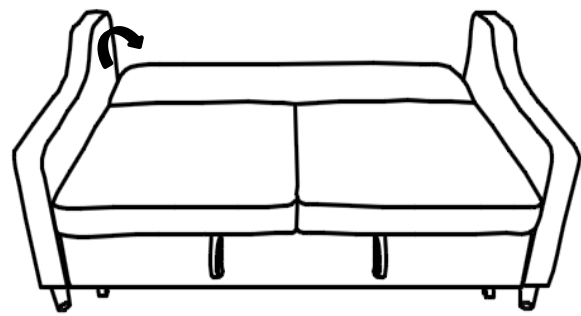

Care Instruction for 100% Polyester Furniture:

In order to maintain the original appearance of your 100% Polyester furniture, please follow below simple care proceures:

- Avoid exposing furniture directly to sunlight or heating and air conditioning outlets. Sunlight and or exposure to heating and air conditioning outlets will fade/damage fabric.
- Vacuum or wipe with a soft cloth to remove dust.



For item use on wooden floor, hard surfaces or carpets, it is recommended to install protective pads under all legs and supports to avoid/prevent from damages/scratches and discoloration.