

ASSEMBLY INSTRUCTION

ITEM NO: 9624GY-4/9624BU-4 /9624TP-4
Storage Ottoman

NO.	PARTS LIST	QTY	DESCRIPTION
A		1	SEAT FRAME

STEP # 1:

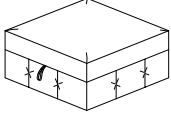
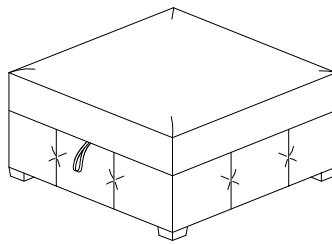

STEP # 2:

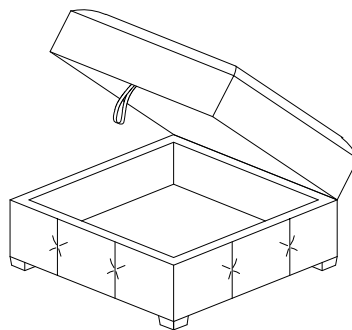

CARE INSTRUCTION FOR FABRIC FURNITURE





In order to maintain the original appearance of your fabric furniture, please follow below simple care procedures.

°Avoid exposing furniture directly to sunlight or heating and air conditioning outlets. Exposure to sunlight or heating and air conditioning outlets will fade/damage fabric.

°Wipe gently with a damp soft cloth to remove dust, dirt and any grime build up.

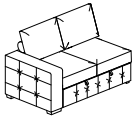
ASSEMBLY INSTRUCTION

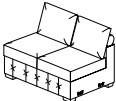
LEGS AND HARDWARE ARE STORED IN THE BOTTOM OF THE SEAT, PLEASE TAKE OUT FOR ASSEMBLY.

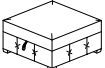
NO.	PARTS LIST	QTY	DESCRIPTION
A		1	9624GY-2L/9624BU-2L
B		1	9624GY-CR/9624BU-CR
C		1	9624GY-2A/9624BU-2A
D		1	9624GY-RC/9624BU-RC
E		1	9624GY-4/9624BU-4

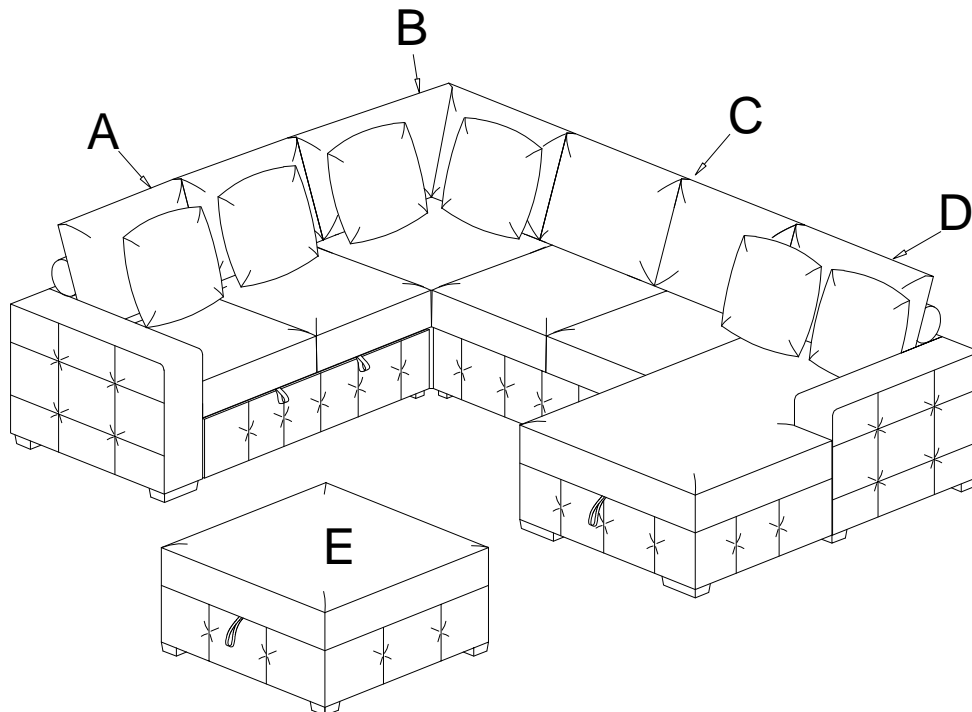

CARE INSTRUCTION FOR FABRIC FURNITURE

In order to maintain the original appearance of your fabric furniture, please follow below simple care procedures.

°Avoid exposing furniture directly to sunlight or heating and air conditioning outlets. Exposure to sunlight or heating and air conditioning outlets will fade/damage fabric.

°Wipe gently with a damp soft cloth to remove dust, dirt and any grime build up.