









# ASSEMBLY INSTRUCTION

ITEM NO: 9688NBE-CR / CORNER SEAT

LEGS, HARDWARE, BACK CUSHION ARE STORED IN THE BOTTOM OF THE SEAT, PLEASE TAKE OUT FOR ASSEMBLY.

NO.	PARTS LIST	QTY	DESCRIPTION
A		1	Seat Frame
B		1	Seat Cushion
C		2	Headrest
D	 38**17"	1	Back Cushion
E	 31-1/2**17"	1	Back Cushion
F	 17**17"	2	Pillow
G	 Ø3-1/8**5-1/8"	4	Wooden Leg
H		4	Washer
I		2	Connector

## STEP 1:

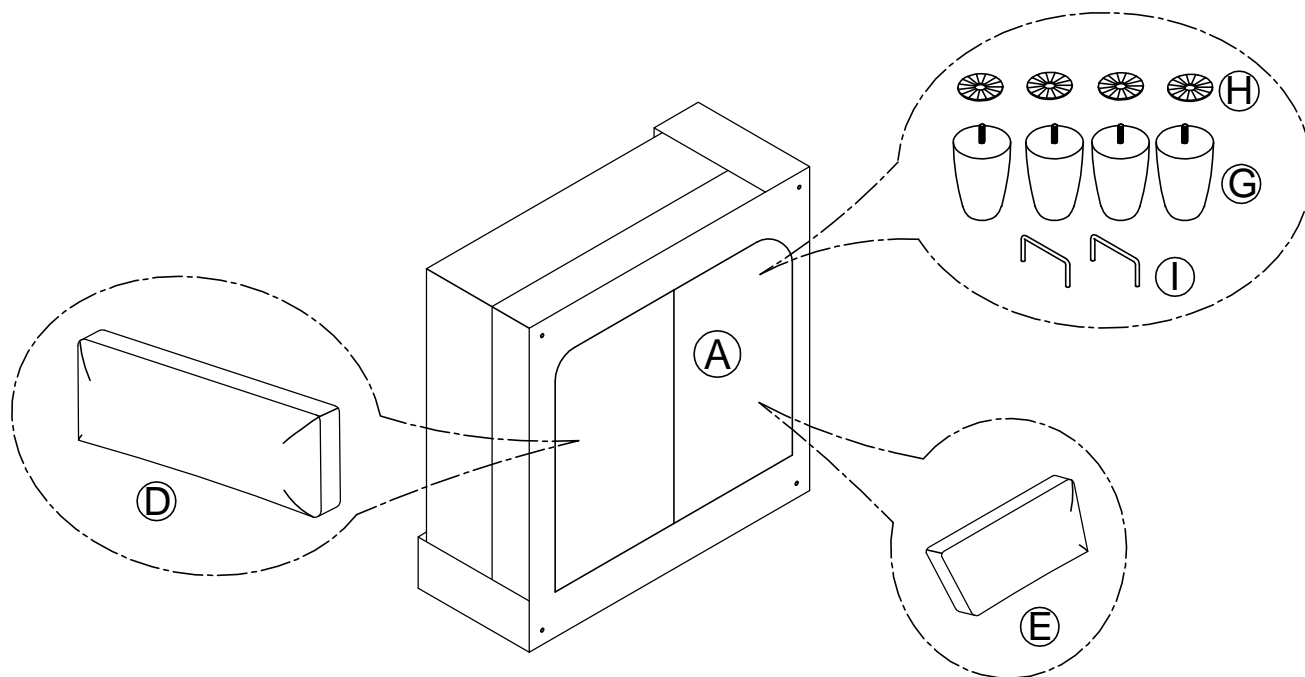

# ASSEMBLY INSTRUCTION

ITEM NO: 9688NBE-CR / CORNER SEAT

## STEP 2:

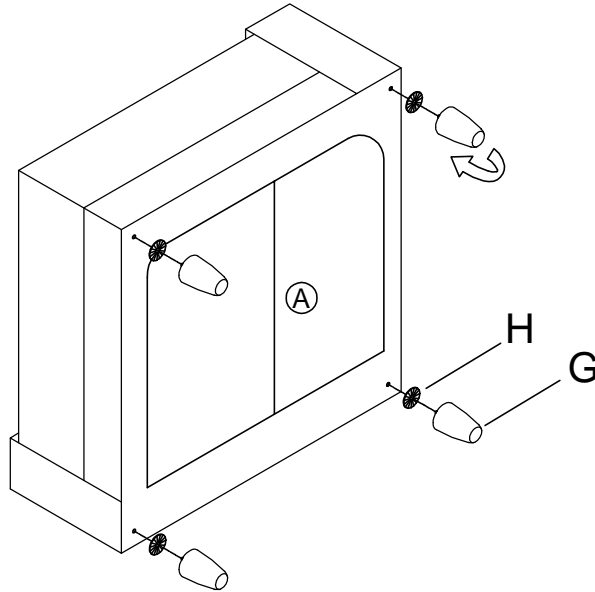

## STEP 3 (Completed) :

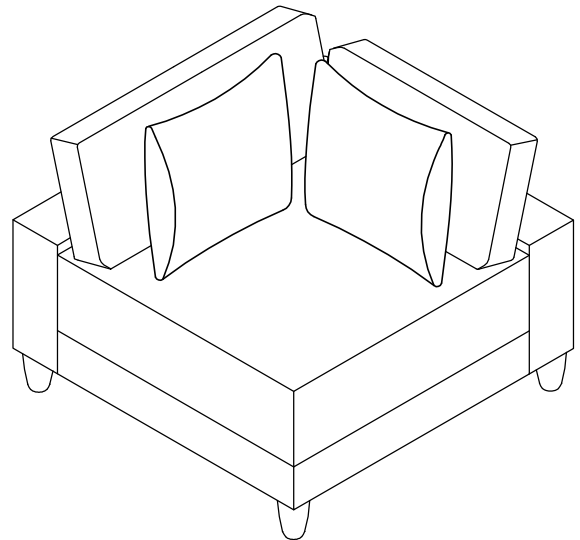
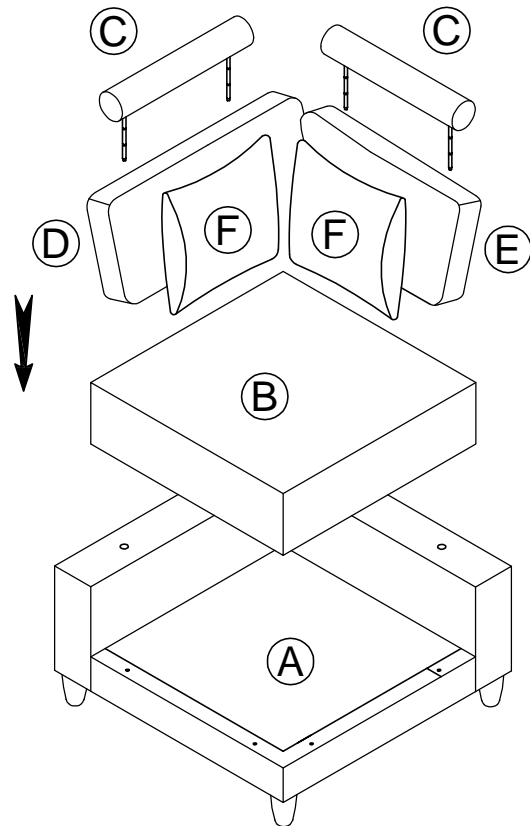

### CARE INSTRUCTION FOR FABRIC FURNITURE

In order to maintain the original appearance of your fabric furniture, please follow below simple care procedures.

°Avoid exposing furniture directly to sunlight or heating and air conditioning outlets. Exposure to sunlight or heating and air conditioning outlets will fade/damage fabric.

°Wipe gently with a damp soft cloth to remove dust, dirt and any grime build up.

Hardware may loosen over time. Periodically check to make sure all connections are tight. Re-tighten if necessary.

# ASSEMBLY INSTRUCTION

ITEM NO: 9688NBE

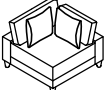
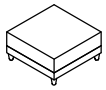
NO.	PARTS LIST	QTY	DESCRIPTION
A		2	9688NBE-AC
B		2	9688NBE-CR
C		1	9688NBE-4

**STEP 1 :**

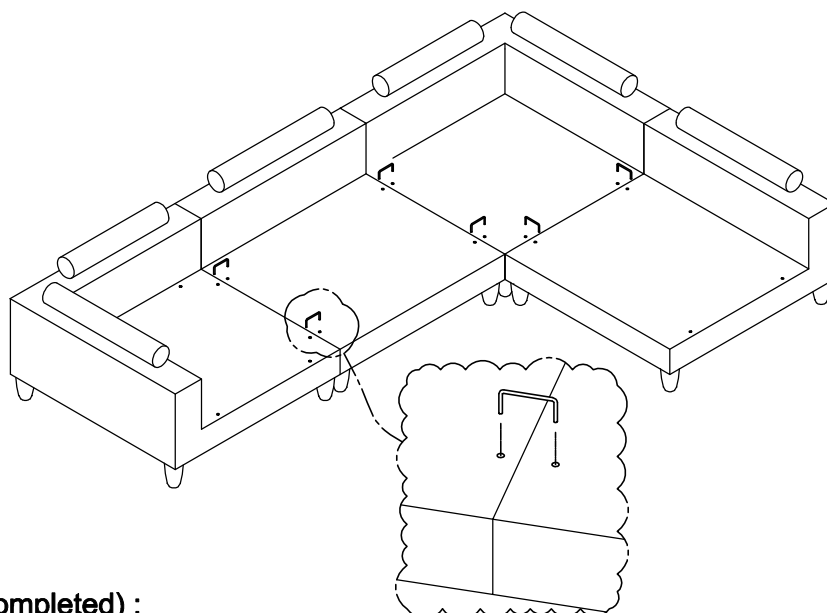

**STEP 2 (Completed) :**

