











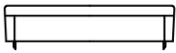

# ASSEMBLY INSTRUCTION

ITEM NO: HM5226DG/GY-3

## SOFA

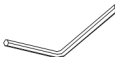
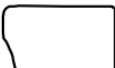
**NOTE: Do not use power tools for assembly. Power tools increase the risk of over tightening which lead to splitting or cracking the wood.**

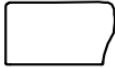
### COMPONENT LIST

NO.	DRAWING	QTY	DESCRIPTION	NO.	DRAWING	QTY	DESCRIPTION
A		1	SEAT	G		4	LEG (H4.75")
B		1	BACK REST	H		2	BOLT (M8*50)
C		1	LSF ARMREST	I		16	BOLT (M6*18)
D		1	RSF ARMREST	J		1	ALLEN KEY
E		1	LSF BACK COUSHION	K		1	MIDDLE LEG (H4.5")
F		1	RSF BACK COUSHION	L		1	WASHER

**Please follow the drawings below to assemble the item.**

**Legs are stored in the box on the seat, please take out for assembly.**

**Step 1.**

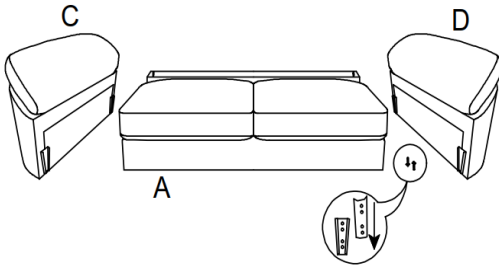

**Step 2.**

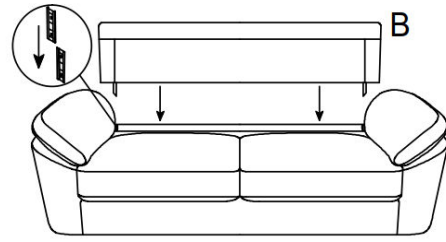

**Step 3.**

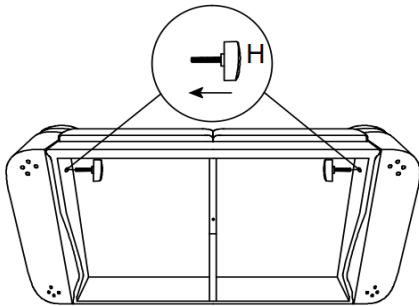

**Step 4.**

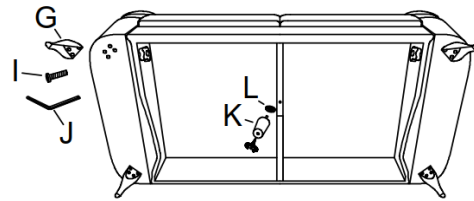

**Step 5.**

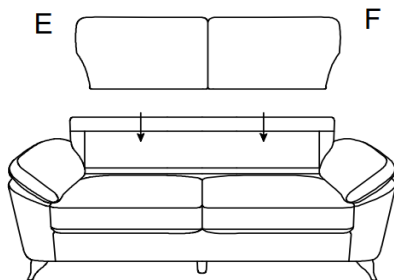

**Step 6.**

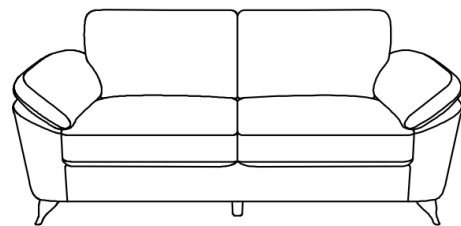

### **CARE INSTRUCTION FOR 100% POLYESTER FURNITURE**

**In order to maintain the original appearance of your 100% polyester furniture, please follow below care procedures:**

- **Avoid exposing furniture directly to sunlight or heating and air conditioning outlets. Exposure to sunlight or heating and air conditioning outlets will fade/damage 100% polyester. Do not place your upholstered furniture too close to windows, radiators, or vents, and be sure to use window treatments to block the sun's rays.**
- **Wipe with a soft brush to remove dust.**
- **Wipe 100% polyester with professional cleanser.**



**For items use on wooden floor, hard surfaces or carpets, it is recommended to install protective pads under all legs and supports to avoid/prevent from damages/scratches and discoloration**