



**ASSEMBLY INSTRUCTION**  
**INSTRUCTION D' ASSEMBLAGE**

HM1378CY - 1 / 3  
 HM1378WL - 1 / 3  
 Kenya Queen Platform Bed

Thank you for purchasing this product. Please take time to read and follow the instruction below. Check that you have all parts and hardware before assembly. Parts apparently missing are often found in the packing materials. If you do not have all parts listed, have your dealer contact us and they will be sent to you immediately.

Merci d' avoir acheté ce produit. Veuillez lire et suivre les instructions ci-dessous. Vérifiez avant le montage que vous avez toutes les pièces et fixations. Les pièces qui semblent manquer se trouvent dans les matériaux d'emballage. Si vous n'avez pas toutes les pièces de la liste, demandez à votre détaillant et nous vous les enverrons immédiatement.

 It is recommended to install protective pads under all legs and support to avoid damage or scratches when placing furniture on a wood floor or other hard surface, and to limit indentation and prevent discoloration if placing on carpet.

 Il est recommandé de placer des coussins protecteurs sous tous les pieds et toutes les bases des meubles pour éviter d'endommager ou d'égratigner les planchers en bois ou autres surfaces dures, et pour limiter l'empreinte et empêcher la décoloration quand les meubles reposent sur la moquette.

**PART LIST**

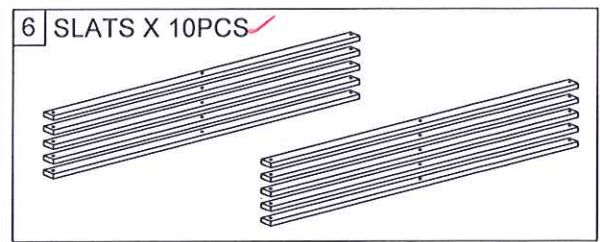
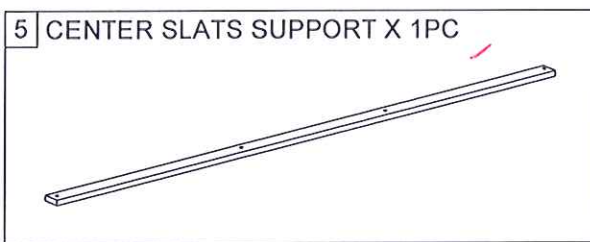
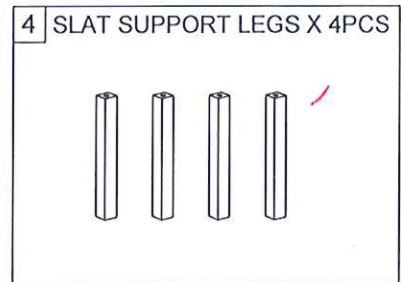
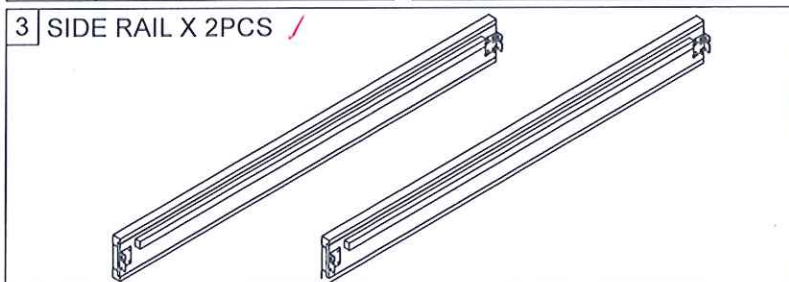

**HARDWARE LIST**

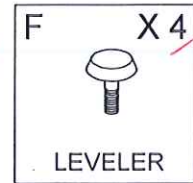
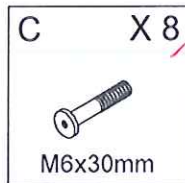
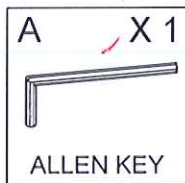

MADE IN MALAYSIA



STEP 1  
SIDE RAIL ASSEMBLY

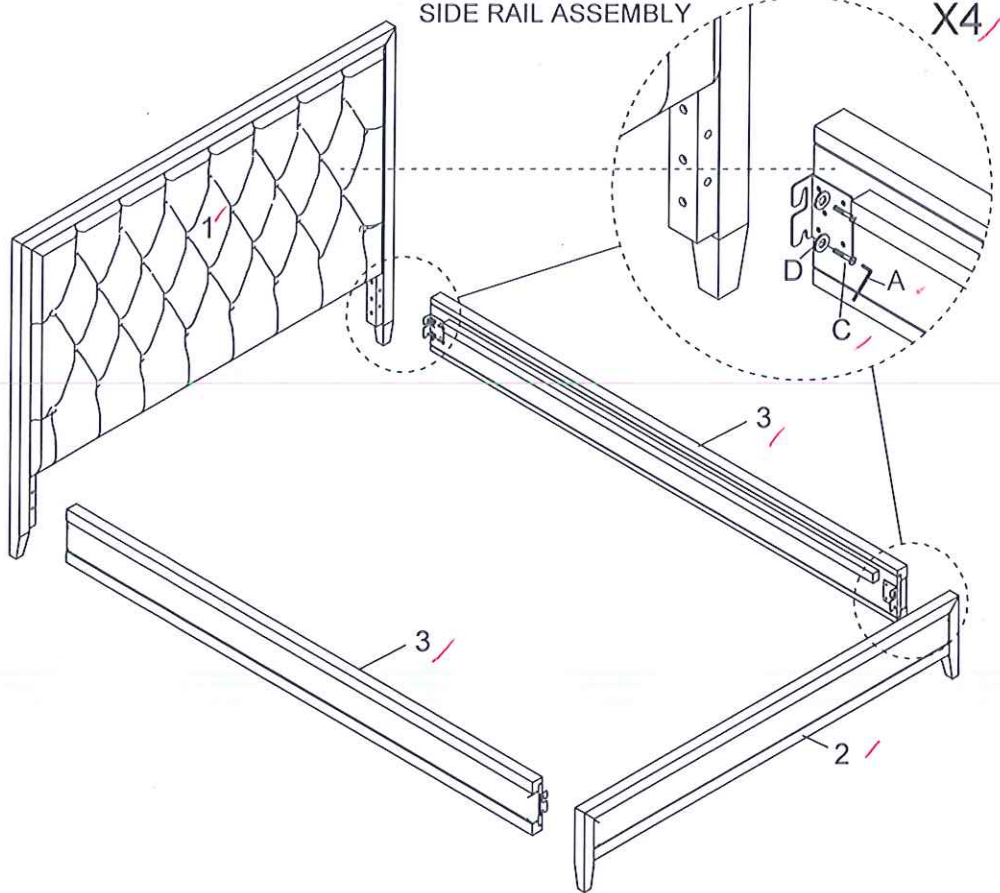

STEP 2  
SLATS / SUPPORT RAIL /  
SUPPORT LEGS ASSEMBLY

