



# ASSEMBLY INSTRUCTION INSTRUCTIONS D'ASSEMBLAGE

ITEM NO : 1534K-1EK / 1534GYK-1EK / 1534WHK-1EK





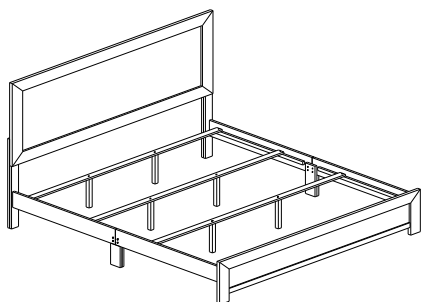

EK BED / TRES GRAND LIT

EK HEADBOARD, FOOTBOARD, SIDE RAIL & SLAT





Thank you for purchasing the product. Please take time to read and follow the instruction below. Check that you have all parts and hardware before assembly. Parts apparently missing are often found in the packing materials. If you do not have all the parts listed, have your dealer contact us and they will be sent to you immediately.

Merci d'avoir acheté ce produit. Veuillez lire et suivre les instructions ci-dessous. Vérifiez avant le montage que vous avez toutes les pièces et fixations. Les pièces qui semblent manquer se trouvent souvent dans les matériaux d'emballage. Si vous n'avez pas toutes les pièces de la liste, demandez à votre détaillant et nous vous les enverrons immédiatement.

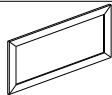
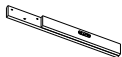
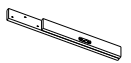

-  **It is recommended to install protective pads under all legs and supports to avoid damage or scratches when placing furniture on a wood floor or other hard surface, and to limit indentation and prevent discoloration if placing on carpet.**
-  **Il est recommandé de placer des coussins protecteurs sous tous les pieds et toutes les bases des meubles pour éviter d'endommager ou d'égratigner les planchers en bois ou autres surfaces dures, et pour limiter l'empreinte et empêcher la décolorations quand les meubles reposent sur la moquette.**
-  **Hardware may loosen over time. Periodically check to make sure all connections are tight. Retighten if necessary.**
-  **Le matériel peut se desserrer au fil du temps. Vérifiez périodiquement que toutes les connexions sont serrées. Serrer à nouveau nécessaire.**
-  **Foundation/box spring required, sold separately.**
-  **Fondation/sommier tapissier requis, vendu séparément.**

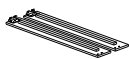
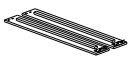
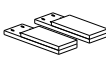
## PART LIST / LISTE DE PIÈCES

No	Sketch	Description	Quantity
1		HEADBOARD / TETE DE LIT	1 PC
2		HEADBOARD LEG - LEFT / PIED GAUCHE	1 PC
3		HEADBOARD LEG - RIGHT / PIED DROITE	1 PC
4		FOOTBOARD / PIED DE LIT	1 PC
5		SIDE RAIL - LEFT / LONGERON GAUCHE	2 PCS
6		SIDE RAIL - RIGHT / LONGERON DROITE	2 PCS
7		SIDE RAIL SUPPORT LEG / LONGERON SUPPORT	2 PCS
8		SLAT / LATTES	4 PCS
9		SLAT SUPPORT / SUPPORT POUR TRANSVERSE	8 PCS

## HARDWARE LIST / LISTE DE LA QUINCAILLERIE

No	Description	Size	Sketch	Quantity
A	JCBB BOLT / BOULON	M8 x 40mm		6 PCS
B	SPRING WASHER / RONDELLE D'ARRÊT	M8		6 PCS
C	FLAT WASHER / RONDELLE PLATE	M8		6 PCS
D	ALLEN KEY / CLÉ ALLEN	M5		1 PC
E	JCBB BOLT / BOULON	M8 X 16mm		8 PCS
F	JCBC BOLT / BOULON	M6 X 40mm		16 PCS
G	SPRING WASHER / RONDELLE D'ARRÊT	M6		16 PCS
H	FLAT WASHER / RONDELLE PLATE	M6		8 PCS
I	ALLEN KEY / CLÉ ALLEN	M4		1 PC
J	SCREW / VIS	M4 x 32mm		8 PCS

\*\* ABOVE HARDWARE ARE PACKED IN 1534K-1EK / 1534GYK-1EK / 1534WHK-1EK FOR ASSMEBLY  
\*\* L'ENSEMBLE DE QUINCAILLERIE EST DANS BOÎTE 1534K-1EK / 1534GYK-1EK / 1534WHK-1EK

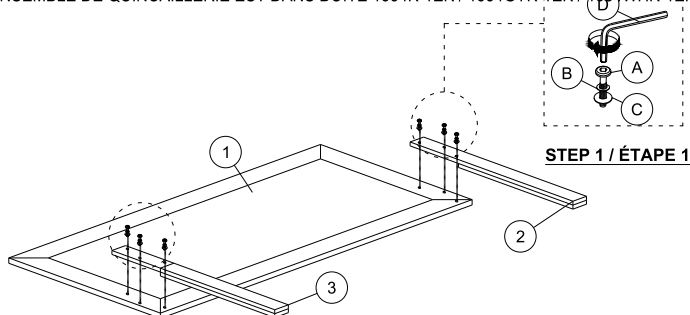

NOTE: You will also need a Philip screw driver (not provided) / Remarque: vous aurez également besoin d'un tournevis Philip (non fourni)



# ASSEMBLY INSTRUCTION INSTRUCTIONS D'ASSEMBLAGE

ITEM NO : 1534K-1EK / 1534GYK-1EK / 1534WHK-1EK  
EK BED / TRES GRAND LIT  
EK HEADBOARD, FOOTBOARD, SIDE RAIL & SLAT

