





4615-F1/F2/F3/F4



LIFT TOP STORAGE BENCH W/PULL-OUT BED Assembly Instruction

Thank you for your purchase of the Homelegance lift top storage bench w/pull-out bed. Please check below instruction for assembly.

PART LIST

NO.	DRAWING	QTY	DESCRIPTION
A		1pc	Pull Out Bed
B		1pc	Pillow
C		4pcs	Caster
D		4pcs	Plastic Leg Ø2"

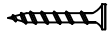
HARDWARE LIST

E		8pcs	Screw #8 x 25mm
F		4pcs	Screw #8 x 45mm

NOTE: Do not tighten the bolts until all parts are assembled. Legs, caster and hardware are stored in the bottom of the bench, please take out for assembly.

Configuration

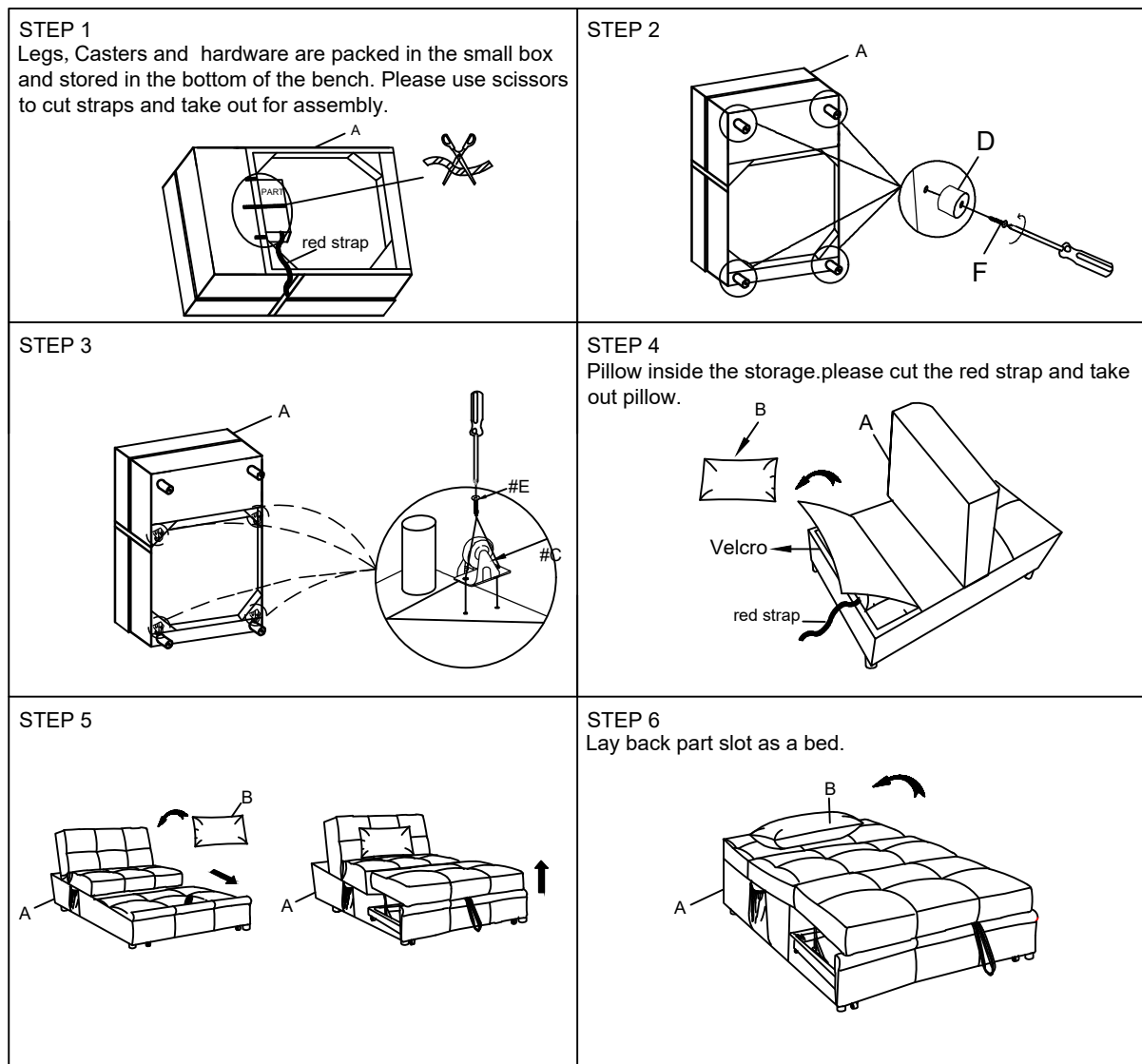

CARE INSTRUCTION FOR FABRIC:

In order to maintain the original appearance of your fabric furniture, please follow below simple care procedure:

- Avoid exposing furniture directly to sunlight or heating and air conditioning outlets. Exposure to sunlight or heating and air conditioning outlets will fade/damage fabric.
- Wipe gently with a damp soft cloth to remove dust, dirt and any grime build up.
- ⚠ It is recommended to install protective pads under all legs and supports to avoid damage or scratches when placing furniture on a wood floor or other hard surface and to limit indentation and prevent discoloration if placing on carpet.