



ASSEMBLY INSTRUCTION

4982F-1 FULL METAL BED

HOMELEGANCE

PART LIST:



A:LSF / RSF HB Leg
2PCS

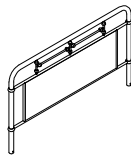

B:Headboard
1PC

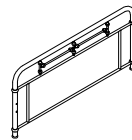

C:Footboard
1PC

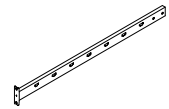

D:Side Rail
2PCS

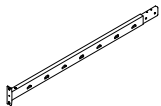

E:Side Rail
2PCS

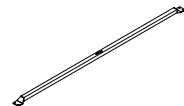

F:Center Cross Bar
1PC

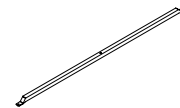

G:Side Cross Bar
2PCS

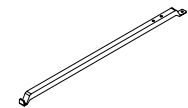

H:Center Rail
Support Bar
2PCS



I:Center Slat
Support Leg
3PCS



J:Center Rail
Support Leg
2PCS

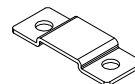

K:Bracket
1PC

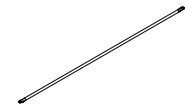

L:Slat
14PCS



M:Slat Connector
28PCS

HARDWARE LIST:



1: Bolt 1/4*22mm
X 16pcs

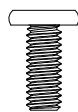

2: Bolt 5/16*19mm
X 8pcs

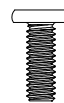

3: Bolt 1/4*17.5mm
X 6pcs



4: Bolt 1/4*40mm
X 4pcs



5: Nut 1/4
X 4psc

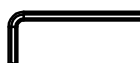

6: Allen Key
X 1pc



7: Wrench
X 1PC

Note: Please do not tighten all bolts until the bed is assembled completely.

STEP 1

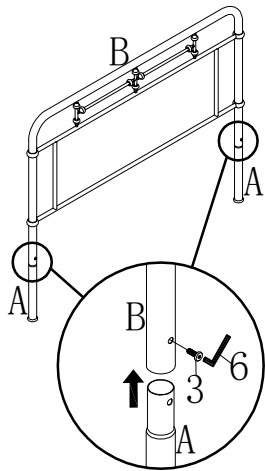

Hardware 3: 2 pcs

STEP 2

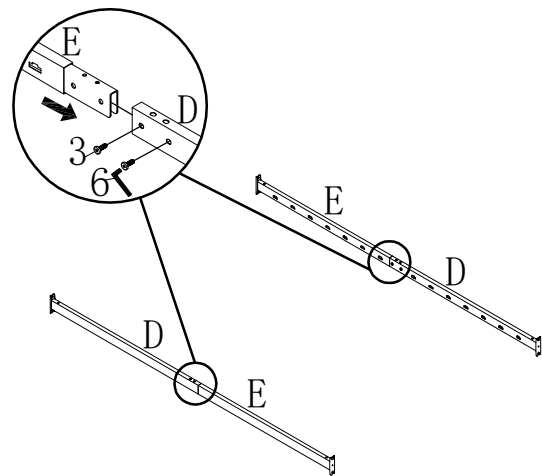

Hardware 3: 4 pcs

STEP 3

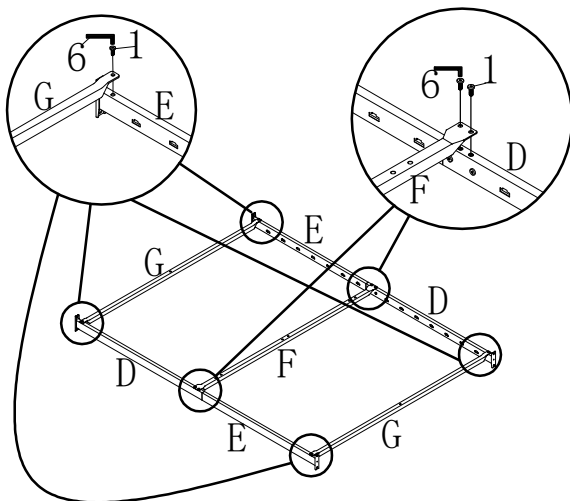

Hardware 1: 8 pcs

STEP 4

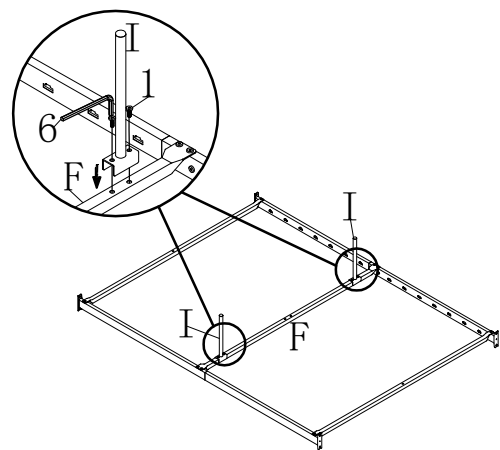

Hardware 1: 4 pcs

STEP 5

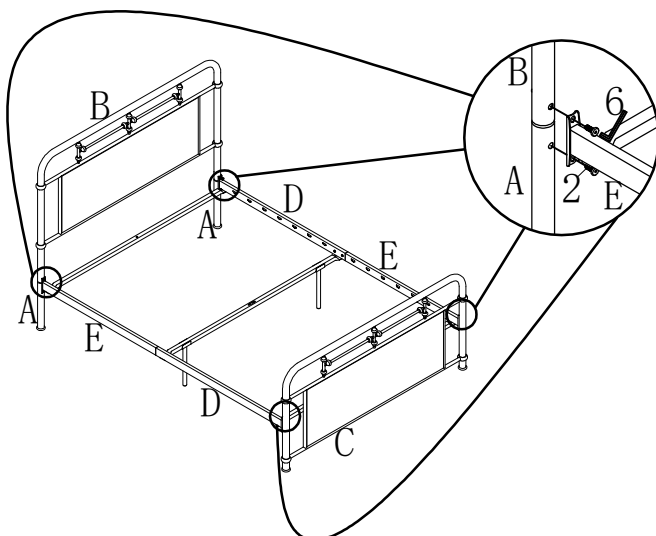

Hardware 2: 8 pcs

STEP 6

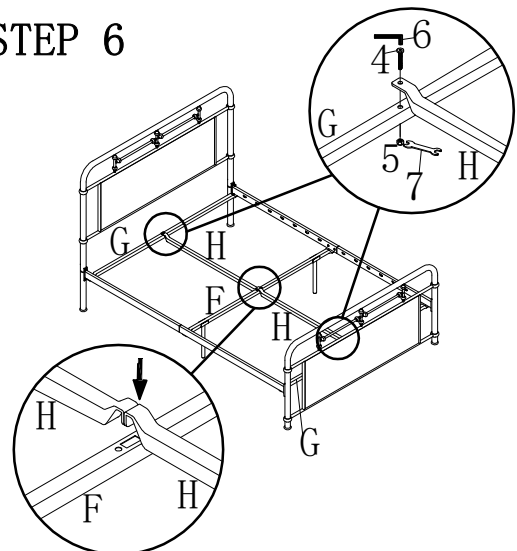

Hardware 4: 2 pcs
Hardware 5: 2 pcs

Note: Please do not tighten all bolts until the bed is assembled completely.

STEP 7

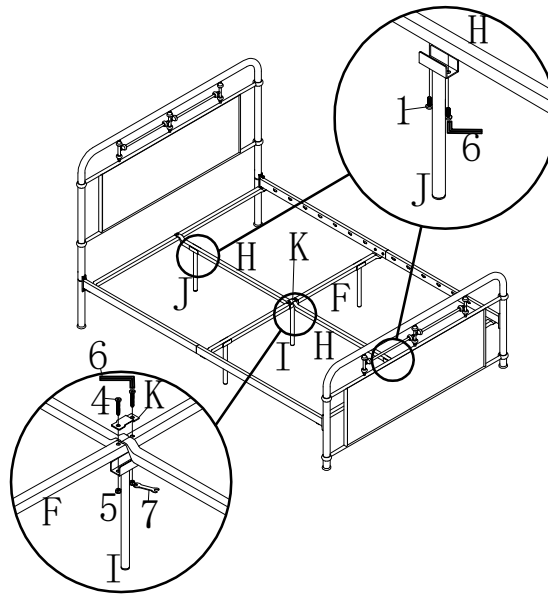

Hardware 1: 4 pcs
Hardware 4: 2 pcs
Hardware 5: 2 pcs

STEP 8

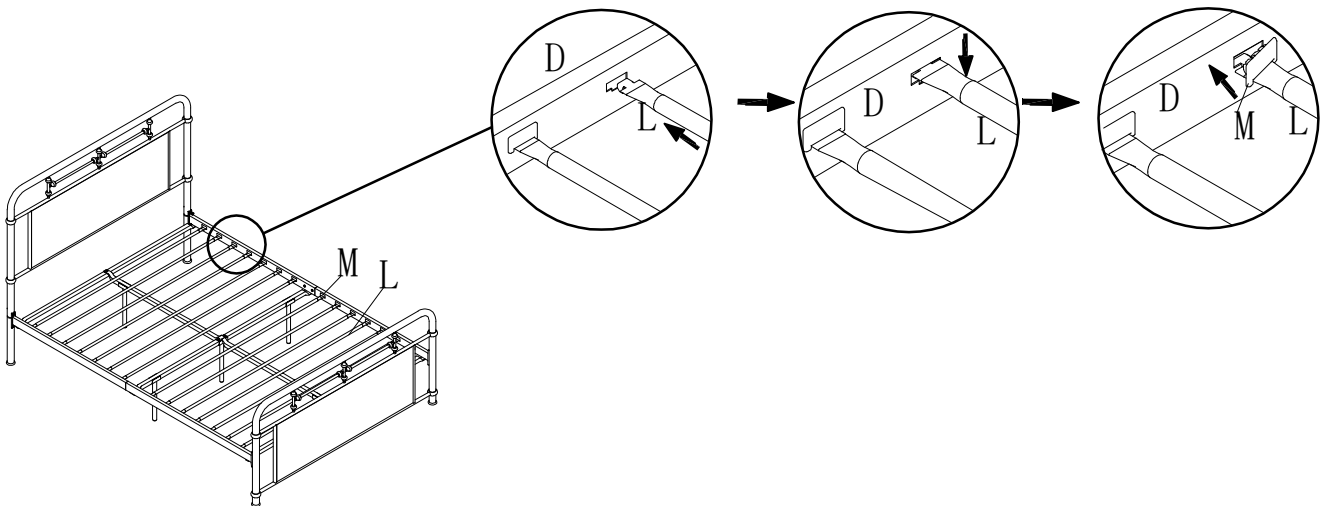

COMPLETED

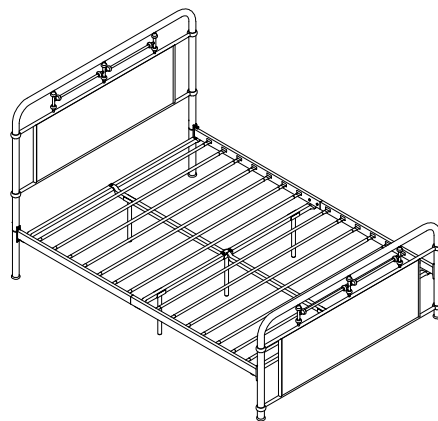

For items use on wooden floor, hard surfaces or carpets, it is recommended to Install protective pads under all legs and supports to avoid/prevent from damages/scratches and discoloration.