

ASSEMBLY INSTRUCTION

ITEM NO : 8555GY-4 Ottoman

 Legs and hardware are stored in the box, please take out for assembly.

NOTE: Do not use power tools for assembly. Power tools increase the risk of over tightening which lead to splitting or cracking the wood.

CHAIR COMPONENT LIST

NO	DRAWING	QTY	DESCIPTION
A		1	SEAT
B		4	PLASTIC LEG
E		12	SCREW #4 X 45MM

NOTE

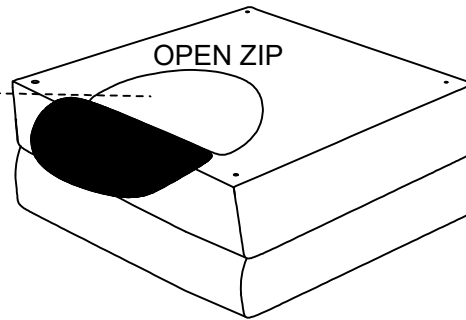
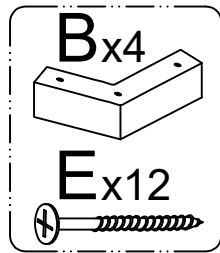

Step1

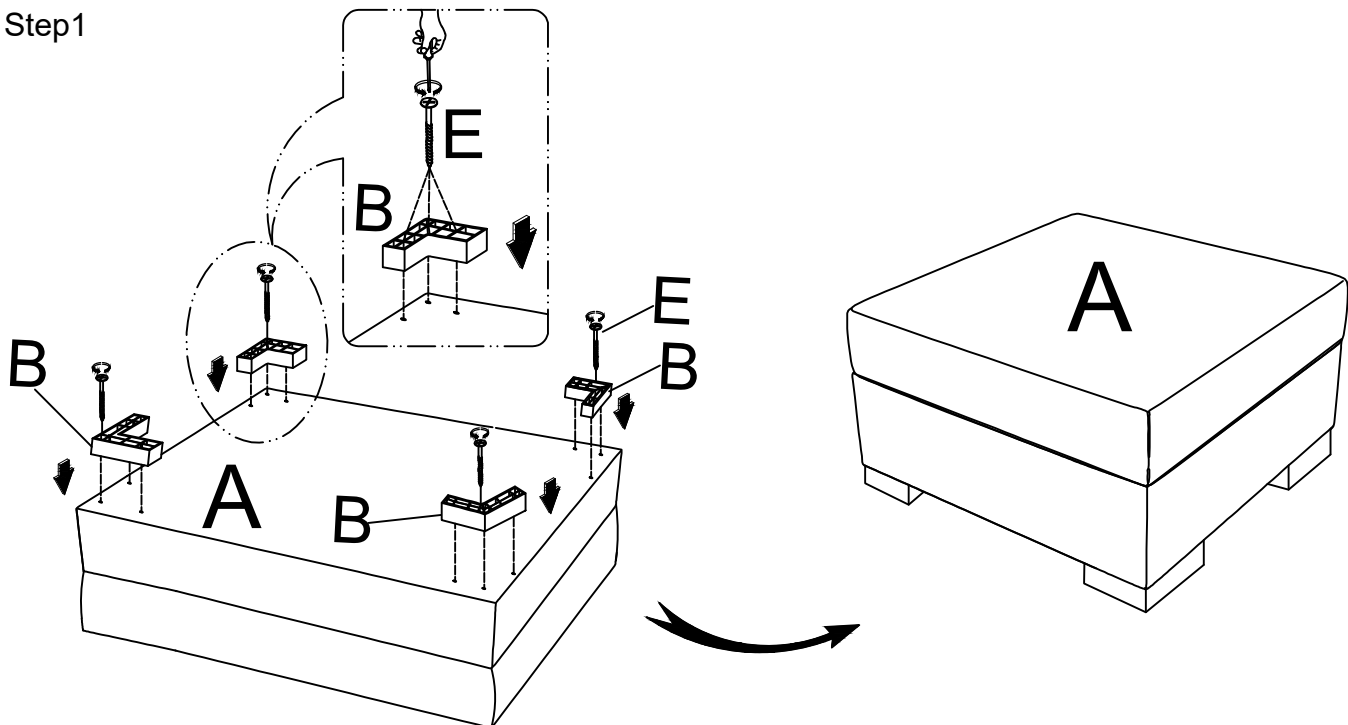

ASSEMBLY INSTRUCTION

ITEM NO : 8555GY/BE-4 Ottoman

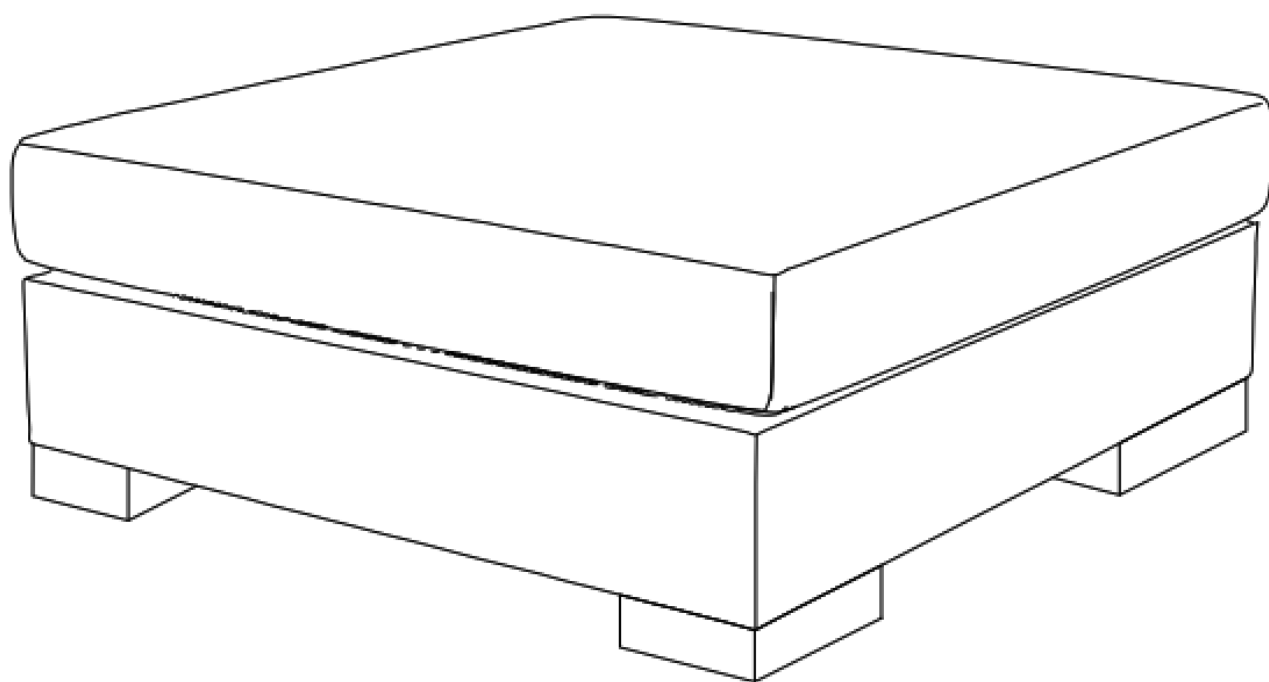

ASSEMBLY INSTRUCTION

ITEM NO : 8555GY/BE-4 Ottoman

STEP 1

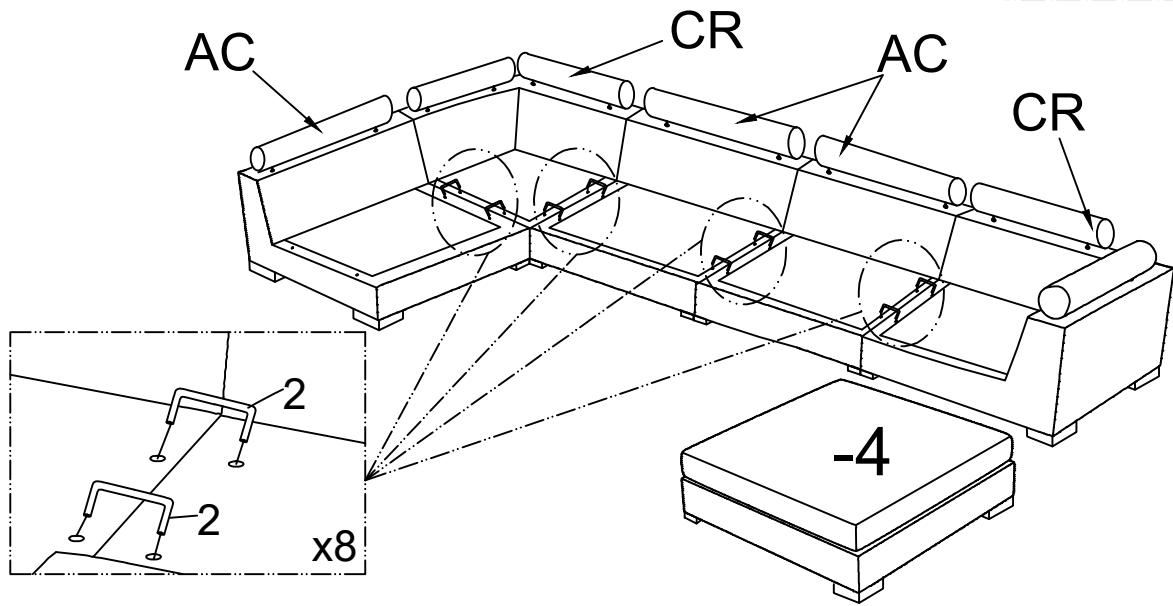

STEP 2

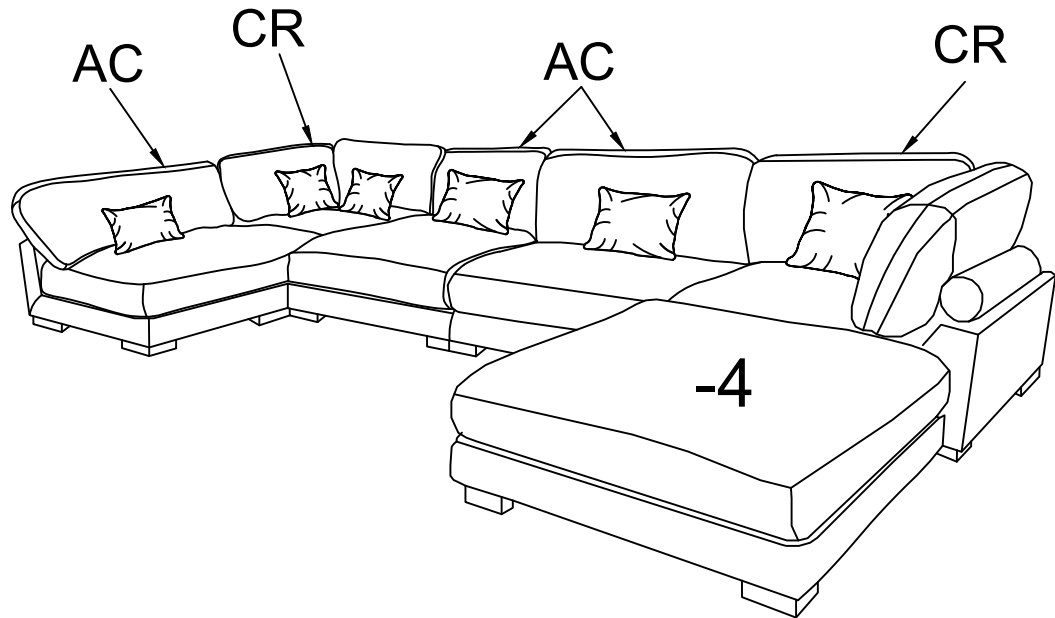

CARE INSTRUCTIONS FOR CORDUROY UPHOLSTERY FURNITURE :

In order to maintain the original appearance of your corduroy furniture, please follow below care procedures:

- Avoid exposing furniture directly to sunlight or heating and air conditioning outlets. Sunlight and / or exposure to heating and air conditioning outlets will fade/damage corduroy. Do not place your upholstered furniture too close to windows, radiators, or vents, and be sure to use window treatments to block the sun's rays.
- Vacuum or wipe with a soft cloth regularly to remove dust.
- Hardware may loosen over time. Periodically check to make sure all connection are tight, Re-tighten if necessary.

 For items use on wooden floor, hard surfaces or carpets, it is recommended to install protective pads under all legs and supports to avoid/prevent from damages/scratches and discoloration.