

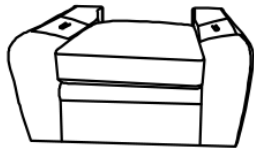





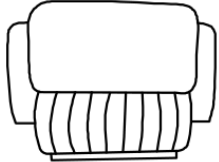

Legs and hardware are stored in the bubble bag and located underneath the seat, please take out for assembly

Note: Do not use power tools for assembly. Power tools increase the risk of over tightening which lead to splitting or cracking the wood

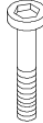
Component list .

| Label | Picture | Description | QTY(pc) |
|-------|---|-------------|---------|
| A |  | SEAT | 1 |
| B |  | LSF ARM | 1 |
| C |  | RSF ARM | 1 |
| D |  | BACK REST | 1 |
| E |  | PLASTIC LEG | 4 |
| F |  | BOLT | 4 |
| G |  | FLAT WASHER | 4 |
| H |  | DRIVER | 1 |

Step #1

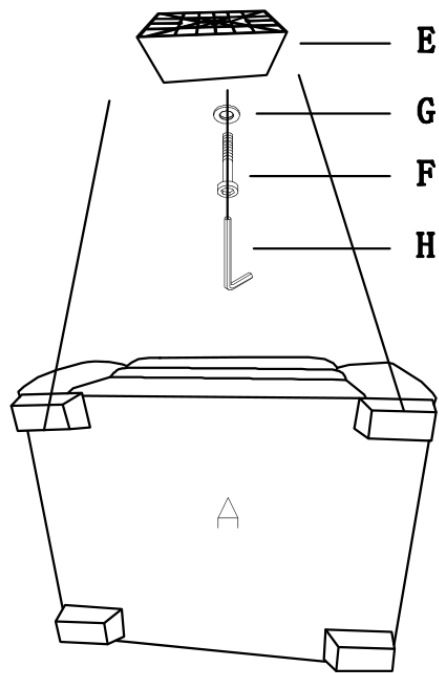

Step #2

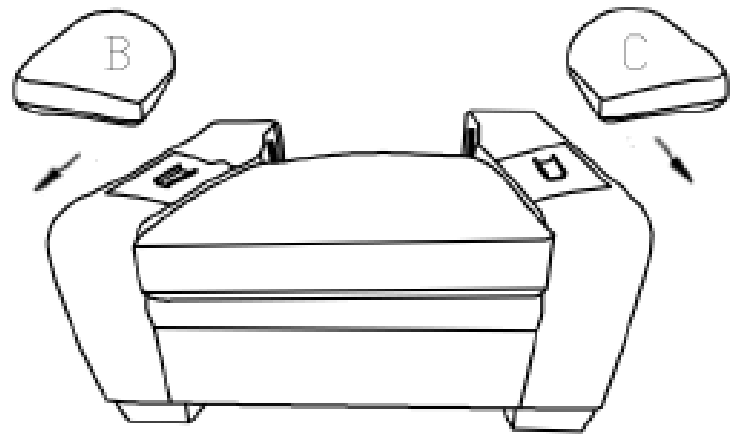

Step #3

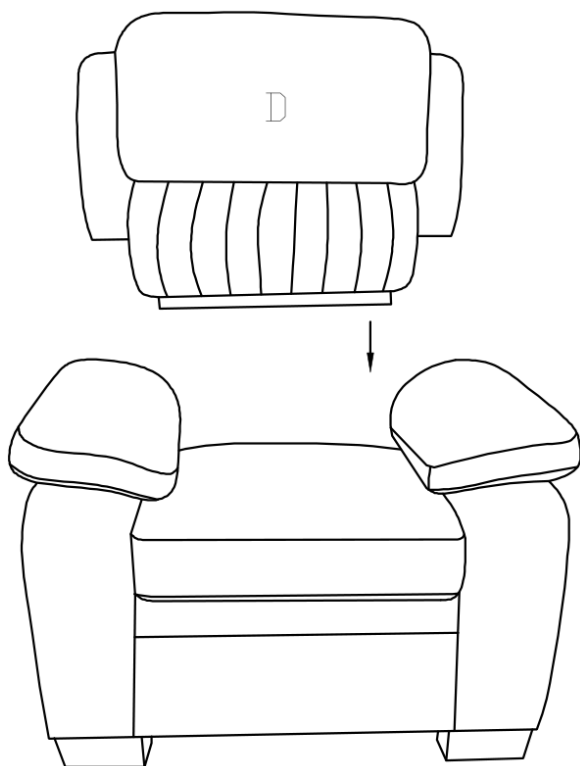

Step #4

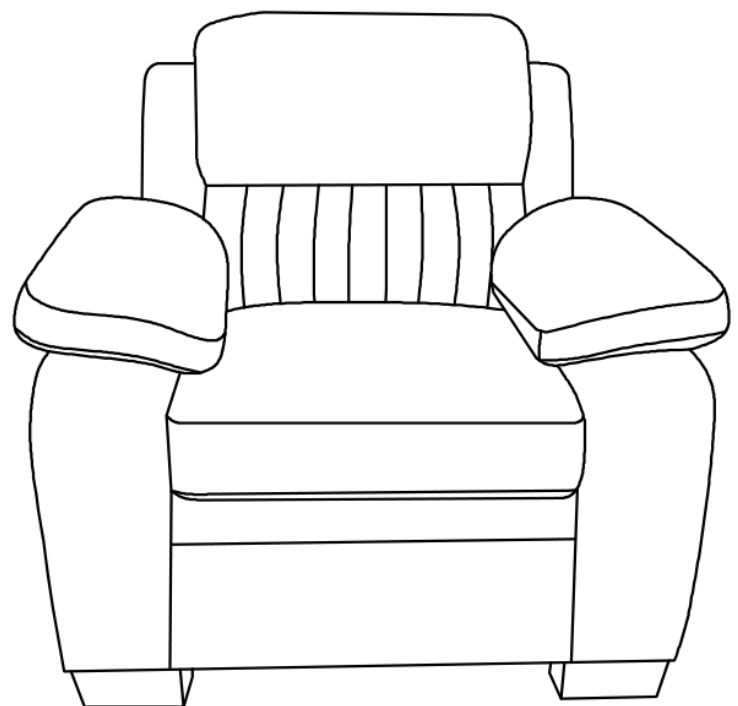

Care Instruction for Textured Fabric Furniture:

In order to maintain the original appearance of your textured fabric furniture, please follow below simple care procedures:

- Avoid exposing furniture directly to sunlight or heating and air conditioning outlets. Sunlight and or exposure to heating and air conditioning outlets will fade/damage textured fabric .
- Vacuum or wipe with a soft cloth to remove dust.



For item use on wooden floor, hard surfaces or carpets, it is recommended to install protective pads under all legs and supports to avoid/prevent from damages/scratches and discoloration.