







Assembly Instruction

ITEM NO.: 9417GRN-3 SOFA WITH 2 PILLOWS

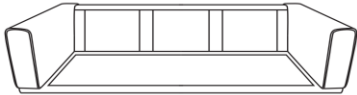
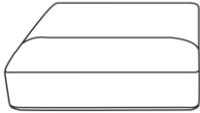
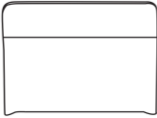

NOTE: Do not use power tools for assembly. The use of power tools increases the risk of over-tightening, which can result in wood splitting or cracking.

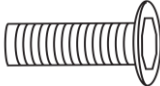
COMPONENT LIST

NO	DRAWING	QTY	DESCRIPTION
A		1	Sofa
B		3	Seat cushion
C		3	Back cushion
D		2	Pillow (18x18")
E		4	Metal legs (H: 20cm)
F		18	Bolt (ØM8x20mm)
G		1	Allen Key (ØM8)

Step1

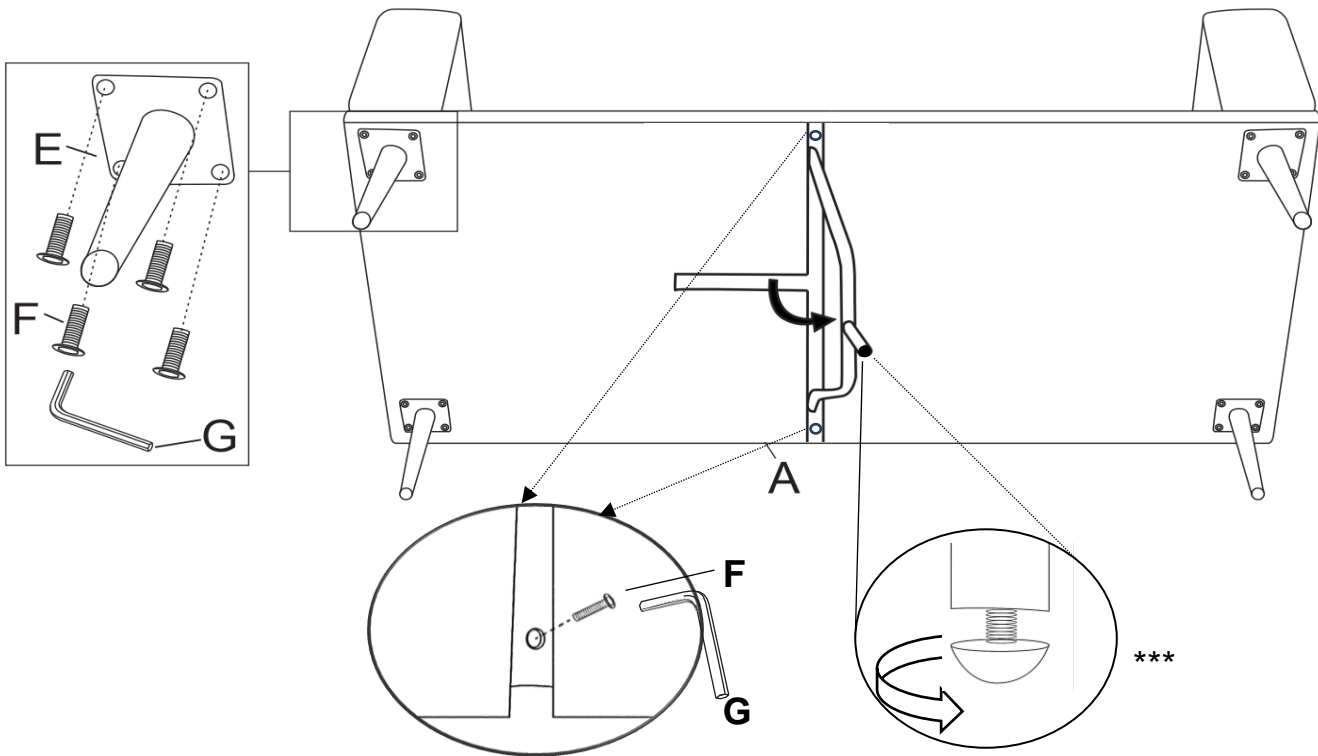

*** Adjust the sofa height to your preference by loosening or tightening the adjustable nut.

Step2

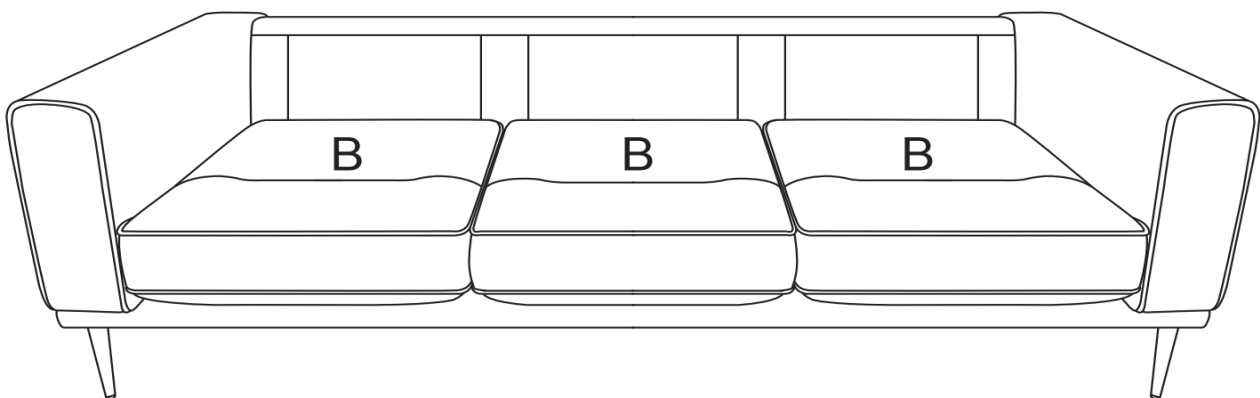

Step3

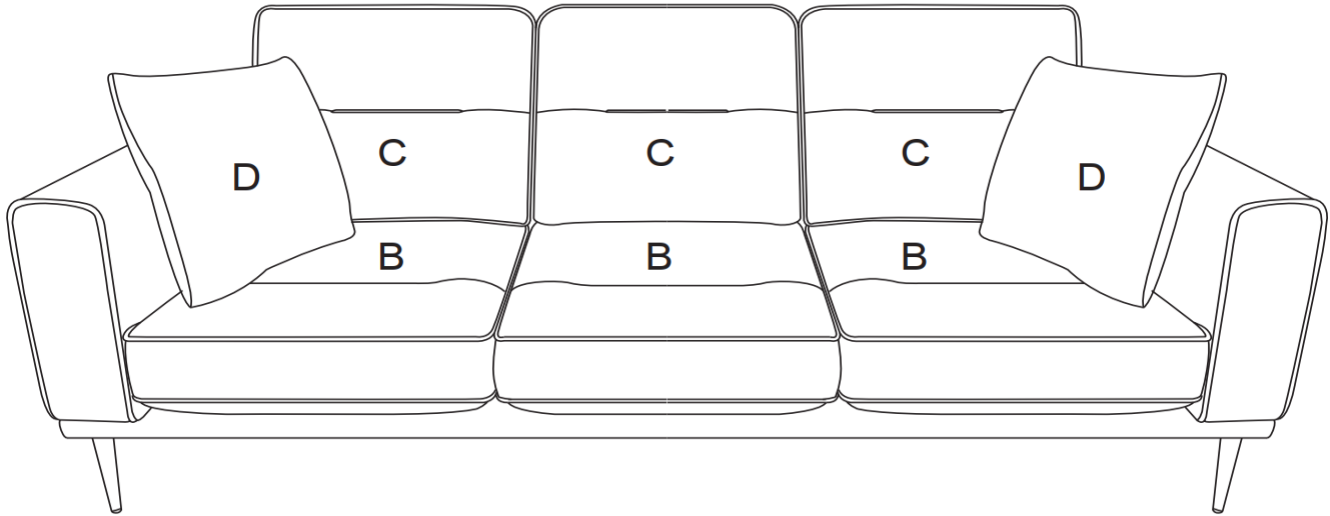

Care Instruction for Velvet Furniture.

In order to maintain the original appearance of your Velvet furniture, please follow below simple care procedures:

- Avoid exposing furniture directly to sunlight or heating and air conditioning outlets. Sunlight and/or exposure to heating and air conditioning outlets will fade/damage Velvet furniture.
- Do not place your upholstered furniture too close to windows, radiators, or vents and be sure to use window, radiators, or vents.
- Vacuum or wipe with a soft brush to remove dust.
- Hardware may loosen over time. Periodically check to make sure all connection are tight, Re-tighten if necessary.



For items used on wooden floor, hard surfaces or carpets, it is recommended to install protected pads under all legs supports to avoid/prevent from damages/ scratches discoloration.