

Assembly Instruction

ITEM NO.:9456DG-1



Glider Reclining Chair



Back rest and Ears are stored in the box, please take out for assembly.

Note: Do not use power tools for assembly. Power tools increase the risk of over tightening which lead to splitting or cracking the wood.

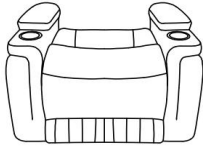
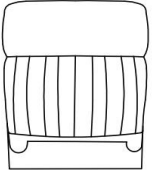
Component list .

Label	Picture	Description	QTY(pc)
A		Seat	1
B		Back Rest	1
C		LSF Ear	1
D		RSF Ear	1

Step #1

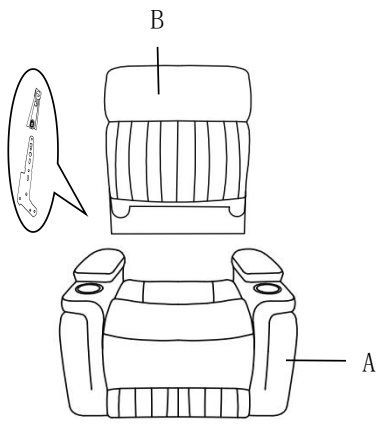

Step #2

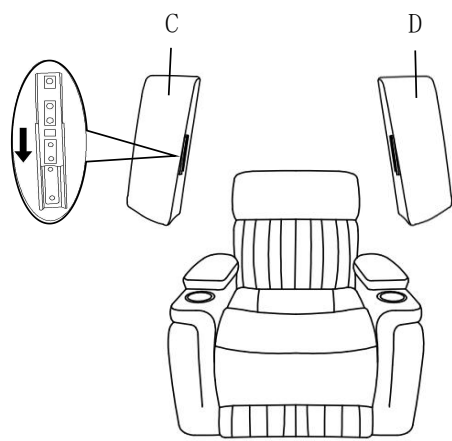

Step #3

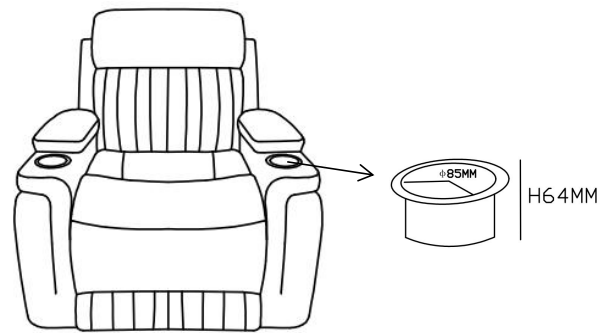
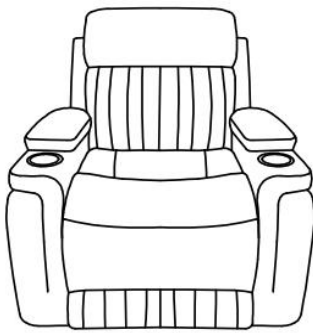

Care Instruction for Leather Air match PU Furniture:

In order to maintain the original appearance of your Leather Air match PU furniture, please follow below simple care proceures:

- Avoid exposing furniture directly to sunlight or heating and air conditioning outlets. Sunlight and or exposure to heating and air conditioning outlets will fade/damage Leather Air match PU.
- Vacuum or wipe with a soft cloth to remove dust.
- Hardware may loosen over time. Periodically check to make sure all connection are tight, Re-tighten if necessary.



For item use on wooden floor, hard surfaces or carpets, it is recommended to install protective pads under all legs and supports to avoid/prevent from damages/scratches and discoloration.