





Assembly Instruction

ITEM NO. 9470GY/BR-2

DOUBLE GLIDER RECLINING LOVE SEAT WITH CENTER CONSOLE
NOTE: Do not use power tools for assembly. Power tools increase the risk of over tightening which lead to splitting or cracking the wood.

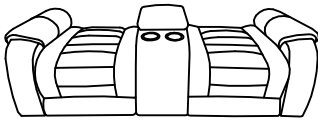
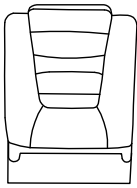
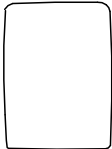
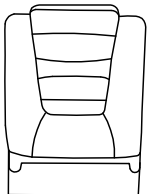
PARTS LIST

NO.	DRAWING	QTY	DESCRIPTION
A		1	SEAT
B		1	LSF BACK REST
C		1	CONSOLE BACK REST
D		1	RSF BACK REST
E		1	LSF EAR
F		1	RSF EAR

Please follow the drawings below to assemble the item.

Step 1. Align the female brackets at the back onto the male brackets at the seat, insert and push to the end, make sure the brackets are secured in position.

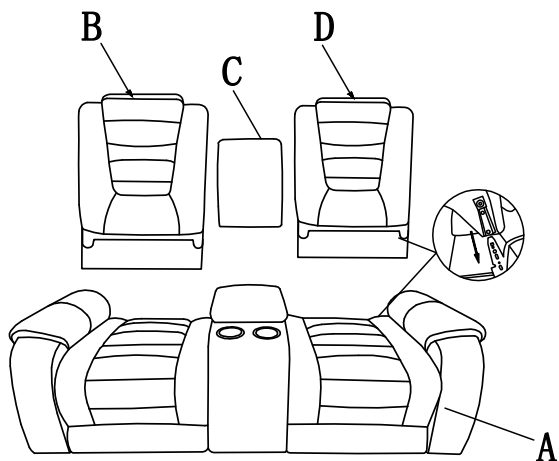

Step 2. Please insert the LSF ear and RSF ear to the back rest and make sure it is secured in position.

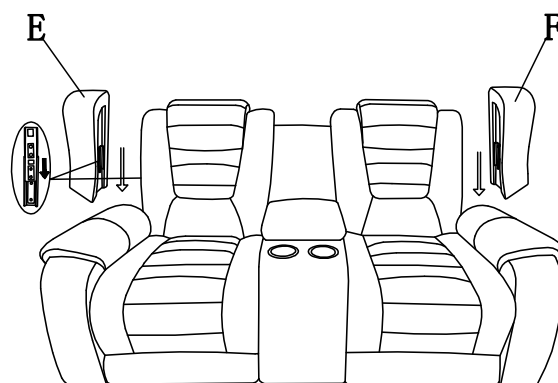

Step 3. Completed.

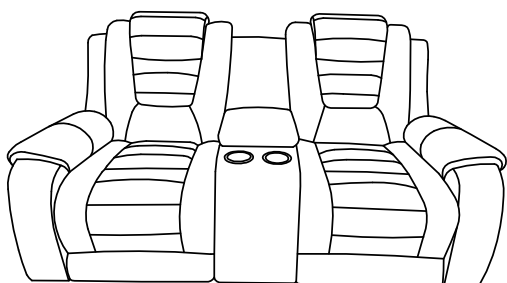

Step 4. Completed.

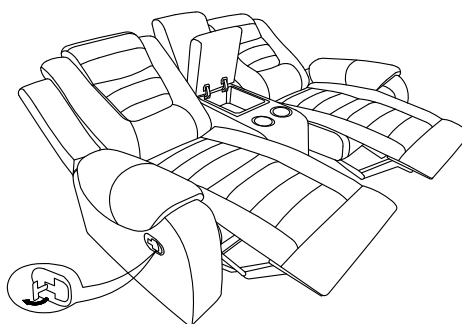

CARE INSTRUCTION FOR LEATHER GEL MATCH FURNITURE:

- Avoid exposing furniture directly to sunlight or heating and air conditioning outlets. Exposure to sunlight or heating and air conditioning outlets will fade/damage leather gel match.
- Wipe gently with a damp soft cloth to remove dust, dirt and any grime build up.



For items use on wooden floor, hard surfaces or carpets, it is recommended to Install protective pads under all legs and supports to avoid/prevent from damages/scratches and discoloration.