



# ASSEMBLY INSTRUCTION

ITEM NO.: 9566DG-L  
LSF 2-SEATER







ITEM NO.: 9566DG-R  
RSF CHAISE



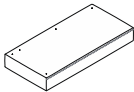
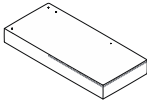

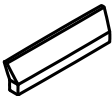

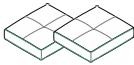

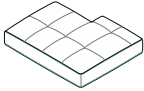
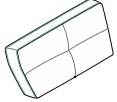
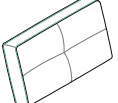
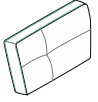

Legs and hardware are stored in the inner box, please take out the legs and hardware for assembly.

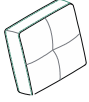











**NOTE:** Do not use power tools for assembly. Power tools increase the risk of over tightening which lead to splitting or cracking the wood

## Component list













NO.	DRAWING	QTY	DESCRIPTION
A		1	LSF 2-SEATER SEAT FRAME
B		1	RSF-CHAISE BACK REST
C		1	LSF 2-SEATER ARM REST
D		1	LSF 2-SEATER BACKREST
E		1	RSF-CHAISE ARM REST
F		1	RSF CHAISE BACKREST
G		2	LSF 2-SEATER LSF/RSF SEAT CUSHION
H		1	RSF-CHAISE REAR SEAT CUSHION

NO.	DRAWING	QTY	DESCRIPTION
I		1	RSF-CHAISE FRONT SEAT CUSHION
J		1	LSF 2-SEATER LSF BACK CUSHION
K		1	LSF 2-SEATER RSF BACK CUSHION
L		1	LSF 2-SEATER FRONT BACK CUSHION
M		1	RSF-CHAISE MIDDLE BACK CUSHION
N		1	RSF-CHAISE REAR BACK CUSHION
O		1	RSF-CHAISE FRONT BACK CUSHION
P		8	PLASTIC LEG
Q		10	LONG BOLT φ1/4" X 3-1/2"
R		10	NUT 7/16" X 3/16"
S		10	FLAT WASHER φ7/8" φ5/16" X 1/16"
T		1	ALLEN WRENCH
U		2	METAL CONNECTOR

### Parts in L

A		1	P		4
C		1	Q		5
D		1	R		5
G		2	S		5
J		1	T		1
K		1			
N		1			

### Parts in R

B		1	M		1
E		1	O		1
F		1	P		4
H		1	Q		5
I		1	R		5
L		1	S		5
			U		2

### STEP #1

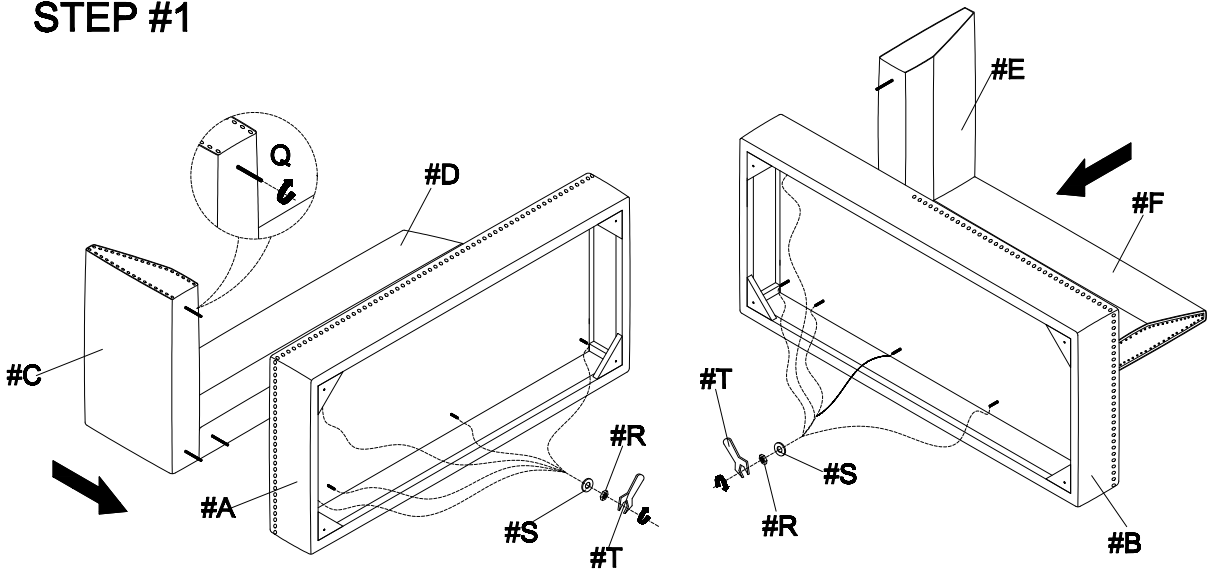

### STEP #2

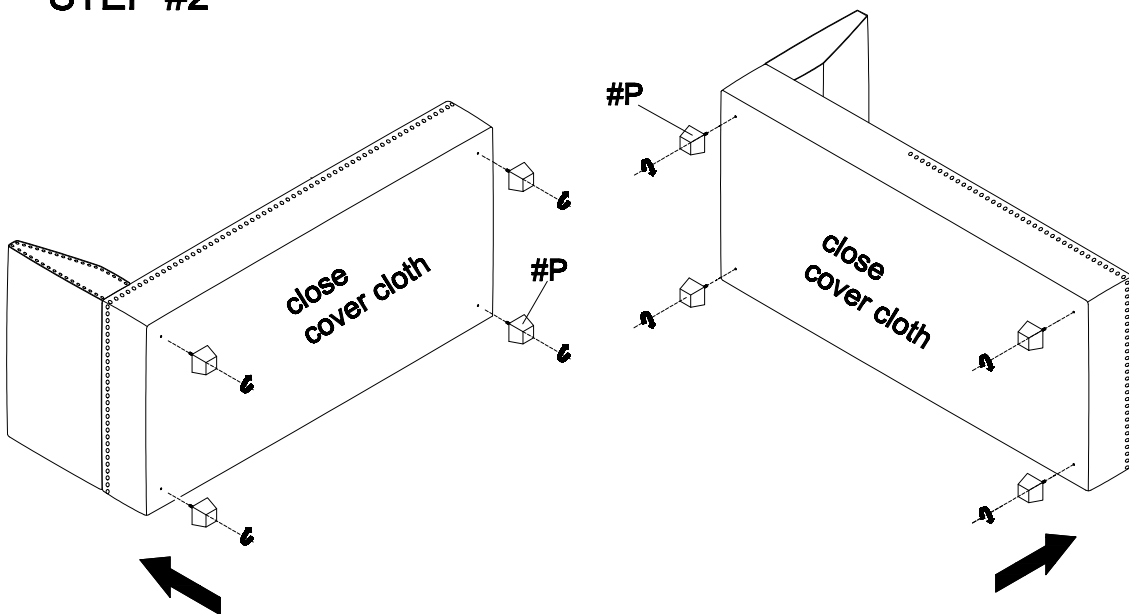

**STEP #3**

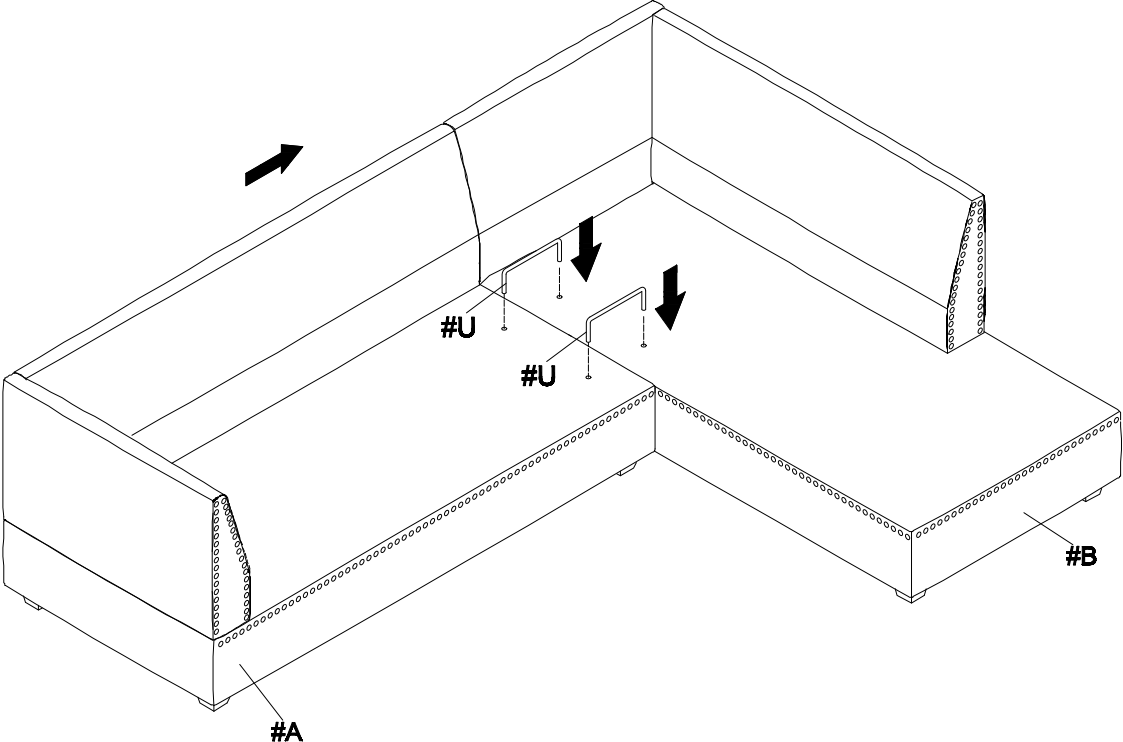

**STEP #4**

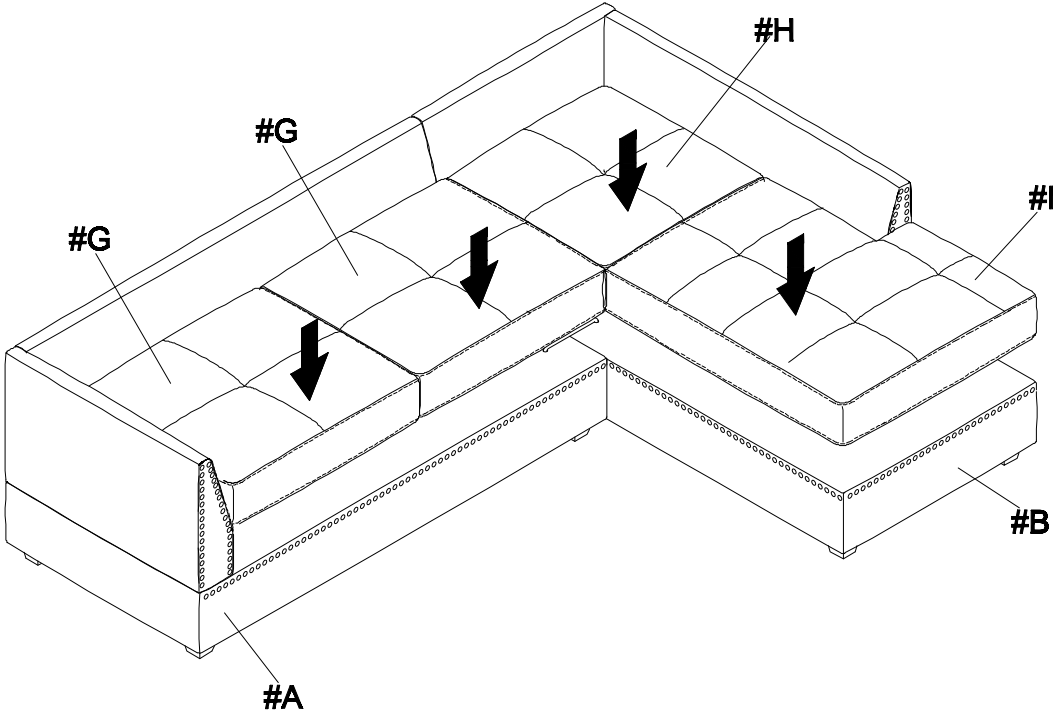

## STEP #5

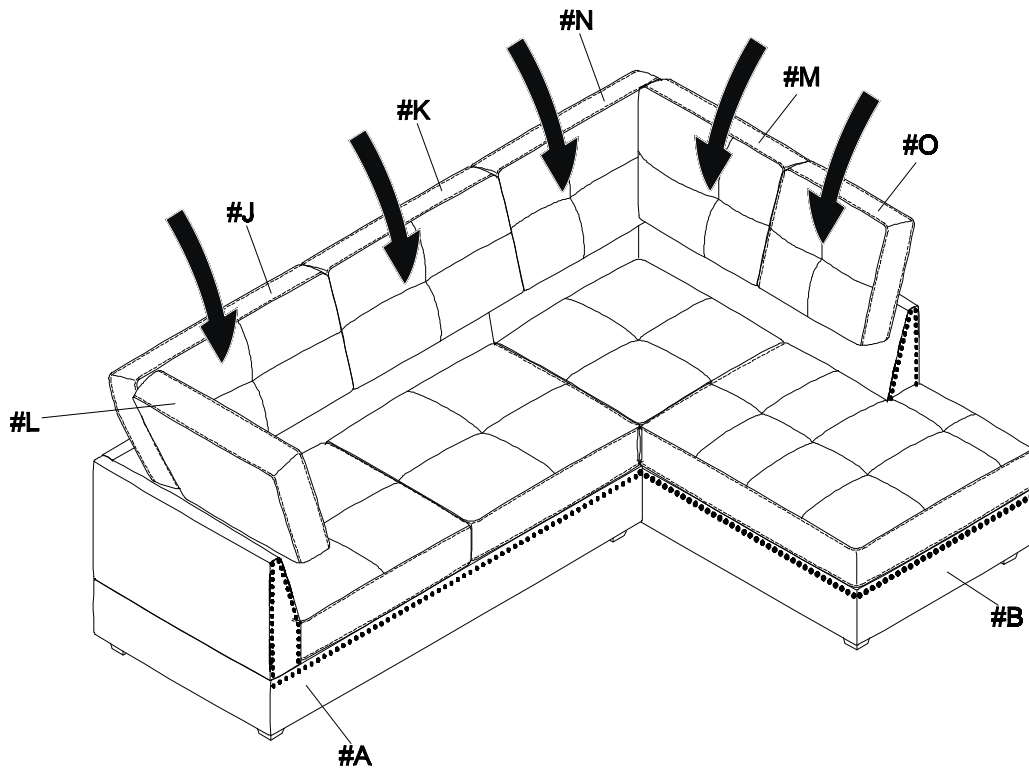

### **Care instruction for 100% polyester.**

**In order to maintain the original appearance of your furniture, please follow below simple care procedures:**

**Avoid exposing furniture directly to sunlight or heating and air conditioning outlet.**

**Sunlight and/or exposure to heating and air conditioning outlets will fade/damage fabric.**

**Vacuum or wipe with a soft cloth to remove dust.**

**Clean fabric with professional cleaner**



**For item used on wooden floor, hard surfaces or carpets it is recommended to install protective pads under all legs and supports to avoid/prevent from damaged/scratches and discoloration.**