







ASSEMBLY INSTRUCTIONS

NO		DESCRIPTION	Q' TY
A		$\phi 1/4''$	8PCS
B		$\phi 1/4''$	8PCS
C		$\phi 1/4'' * 2-1/2''$	8PCS
D		$\phi 1/4'' * 1''$	4PCS
E		$\phi 1/4'' * 1/2''$	4PCS
F			4PCS
G		4mm	1PC

STEP 1

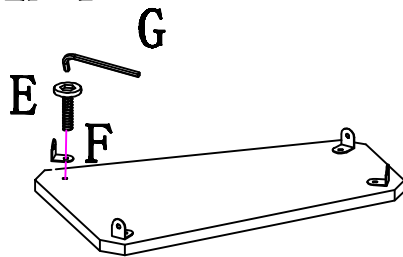

STEP 2

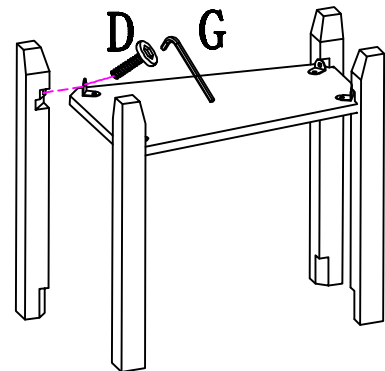

STEP 3

